

# IMPACT/IMPACT PRO

# operating instructions

COMPACT, PORTABLE GAS MONITOR

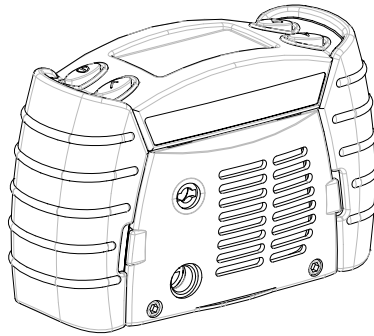

---

## **HELP US TO HELP YOU**

---

Every effort has been made to ensure the accuracy in the contents of our documents, however, Zellweger Analytics Limited can assume no responsibility for any errors or omissions in our documents or their consequences.

Zellweger Analytics Limited would greatly appreciate being informed of any errors or omissions that may be found in the contents of any of our documents and to this end we include the following form for you to photocopy, complete and return to us so that we may take the appropriate corrective action.

---

## HELP US TO HELP YOU

---

<p>To: Marketing Services, Zellweger Analytics Limited, Hatch Pond House, 4 Stinsford Road, Nuffield Estate, POOLE. Dorset. BH17 0RZ. United Kingdom.</p> <p>Tel: +44 (0) 1202 676161 Fax: +44 (0) 1202 678011 email: literature@zelana.co.uk</p> <p>US Office Tel: +1 954 514 2700 Toll free: +1 800 538 0363</p>	<p>From :</p> <p>Address :</p> <p>Tel : Fax : email :</p>
----------------------------------------------------------------------------------------------------------------------------------------------------------------------------------------------------------------------------------------------------------------------------------------------------------------------------------------------------------------	-------------------------------------------------------------------

I suggest the following corrections/changes be made to:  
Chapter ..... Section .....

Marked up copies attached (as appropriate):      Yes / No

Please inform me of the outcome of this change: Yes / No

<p>For Marketing Services, Zellweger Analytics Limited:</p>	
Actioned By:	Date:
Response:	Date:

---

## GENERAL STATEMENT OF LIMITED WARRANTY

---

### COPYRIGHT

This publication contains information partly derived from proprietary data of Zellweger Analytics. The main objective of this information is to assist in the operation and maintenance of the instrument described herein. The publication of this information does not convey any right to reproduce or use the information for any purpose other than in the operation or maintenance of the equipment described herein.

Zellweger Analytics shall not be liable for any incidental or consequential damages in connection with any deletions, errors or omissions in this Manual.

All products are designed and manufactured to the latest internationally recognised standards by Zellweger Analytics under a Quality Management System that is certified to ISO9001. As such Zellweger Analytics warrants its products against defective parts and workmanship as detailed below.

1. Zellweger Analytics Limited will repair or (at its option) replace any Contract Goods which are or may become defective under proper use within the following timescales from Delivery where such defects solely arise from faulty design materials or workmanship (Other than a design made furnished or specified by the Buyer) provided such defective goods are returned by the Buyer within the requisite time limits set out below at its expense to Zellweger Analytics Limited's premises, which returned goods must detail the Service Event Number (SE#) clearly on the package and the Buyer shall obtain an SE# by telephoning Zellweger Analytics Limited Service Department.

---

## GENERAL STATEMENT OF LIMITED WARRANTY

---

2. All products 12 months from delivery (date of original despatch to the buyer) with the following exceptions:

**Impact** multigas detector  
24 months from delivery

**Impact** disposable OFCH cartridge  
12 months from date of installation into Impact instrument provided installation takes place before the stated 'INSTALL BY' date on the cartridge packaging

3. Any such defective goods returned in accordance with the provisions of this clause must be accompanied by a detailed report stating the nature of the defect with the SE#. If no such report is included then Zellweger Analytics Limited reserve the right to charge a £50 (Sterling)/\$75 (US dollars) investigative fee before any repair or replacement is carried out.
4. The warranties set out in this clause are non pro rata, i.e. the initial warranty period is not extended by virtue of any works carried out there under.
5. Where it is impractical to return any defective goods to Zellweger Analytics Limited's premises then Zellweger Analytics Limited should be notified by writing within the relevant warranty period referred to above and upon being so notified Zellweger Analytics Limited will despatch a service engineer to site on a day rate basis (details available upon request) and if such goods are found to be defective hereunder then they will be repaired or replaced free of charge but day rate charges for the service engineer will apply.
6. Subject to the provisions of this clause Zellweger Analytics Limited shall not be liable for any loss or damage whatsoever or howsoever occasioned which may be a direct or indirect result of the use or operation of the Contract Goods by the buyer or any Party.

---

## **GENERAL STATEMENT OF LIMITED WARRANTY**

---

7. This warranty covers instrument and parts sold to the Buyer only by authorised distributors, dealers and representatives as appointed by Zellweger Analytics Limited.
8. This warranty does not cover consumable items or items likely to wear in normal operation including but not limited to dry-cell batteries, filters and fuses.
9. The liability of Zellweger Analytics Limited under this clause shall be in lieu of any warranty or conditions implied by law as to the quality or fitness for any particular purpose of the Contract Goods and (save as provided in this clause) Zellweger Analytics Limited shall not be under any liability whether in contract tort or otherwise in respect of any defects in the Contract Goods or for any injury (other than personal injury caused by Zellweger Analytics Limited's negligence as defined by Section 1 of the Unfair Contract Terms Act 1977) damage or loss resulting from such defects or from work done in connection therewith.
10. This warranty supersedes all existing warranty statements and Zellweger Analytics Limited make no other warranty expressed or implied except as stated above.
11. If a claim is made against Zellweger Analytics Limited in respect of Liability under the Consumer Protection Act 1987 in circumstances where a like claim could have been made against the Buyer in contract the buyer should indemnify Zellweger Analytics Limited in full against all damages costs and expenses that may become payable as the result of such claim.

---

## TOTAL ENVIRONMENTAL SOLUTIONS

---

Ensure that you read and understand these Operating Instructions BEFORE installing or operating any part of the equipment.

Please pay particular attention to the Safety Warnings.

### WARNINGS

The dry cell battery holder part no. 2302B0371 or rechargeable battery pack part no. 2302B0842 must not be removed, replaced or recharged in the hazardous area.

Only the following alkaline dry cell batteries must be used in the dry cell holder part no. 2302B0371.

Duracell MN1500 or Energizer Intelligent E91.

Rechargeable cells must not be used in the dry cell battery holder part no. 2302B0371.

Do not mix rechargeable battery packs and dry cell battery packs.

The Impact must only be serviced by qualified personnel trained by Zellweger Analytics or by a Zellweger Analytics Appointed Distributor

The Impact must not be used in an oxygen enriched atmosphere.

Refer to Section 4. *OPERATION* for details of restrictions of use of the IMPACT/IMPACT PRO

The Flammable Sensor requires an oxygen content of greater than 10%v/v to operate reliably. In circumstances where the oxygen content of the sample is less than 10%v/v, the reading displayed on the Flammable Channel should be regarded as suspect. In this situation, a Warning 54 (Low O<sub>2</sub> - Flam Inaccurate) will be generated on the instrument.

---

## TOTAL ENVIRONMENTAL SOLUTIONS

---

### WARNINGS

The Flammable Sensors sensitivity can be adversely affected by exposure to certain substances (silicon and sulphur compounds are examples). Every effort should be made to avoid exposure to these substances. Following an H<sub>2</sub>S alarm or repeated gassing with H<sub>2</sub>S a check should be performed on the Flammable sensor to verify its accuracy and a calibration performed if necessary.

If -0.0 Vol.% for the CO<sub>2</sub> sensor channel is permanently displayed, a sensor zero (during boot procedure) or a zero calibration needs to be performed in clean air. The alarm level A1 for the CO<sub>2</sub> range must not exceed 0.5 Vol.%.

Dispose of the spent cartridge and its packaging in accordance with local regulations. Do not dispose of in fire.

### CAUTIONS

The IMPACT/IMPACT PRO must be serviced only by qualified personnel trained by Zellweger Analytics or by a Zellweger Analytics appointed agent.

### IMPORTANT NOTICE

Zellweger Analytics Limited can take no responsibility for installation and/or use of its equipment if this is not done in accordance with the appropriate issue and/or amendment of the relevant manual.

The user of this manual should ensure that it is appropriate in all detail to the exact equipment to be installed and/or operated. If in doubt, the user should contact Zellweger Analytics Limited for advice.

If further details are required which do not appear in this manual, contact Zellweger Analytics Limited or their agent.

*Note: The failure to observe and abide by the above Warnings and Cautions may render void the intrinsic safety approval of the IMPACT/IMPACT PRO, and may remove any right of claim against Zellweger Analytics relating to product liability or consequential damage to any third party.*

---

# CONTENTS

---

Section	Page
1. INTRODUCTION	16
1.1 Intended use	17
1.2 Product overview	18
2. GETTING STARTED	20
2.1 How to turn Impact/Impact Pro on and off	20
2.2 Inserting the cartridge	21
2.3 Charge for first use	22
2.4 Dry-cell Battery insertion	25
2.5 Sampling	26
3. INSTRUMENT START-UP	28
3.1 Instrument information	28
3.2 Selecting location / operator	29
3.3 Fresh Air Auto zeroing sensors	29
3.4 Sensor Warm-up Phase	30
4. OPERATION	31
4.1 Monitoring Condition	31
4.1.1 Display Screens	31
4.1.2 Other Displayed Symbols	33
4.1.3 Confidence Signal	34
4.1.4 Go/No Go Option	34
4.2 Atmospheric alarm conditions	35
4.3 Alarm condition	36
4.3.1 Latching Alarms (default)	36
4.3.2 Non-latching Alarms	36
4.3.3 Vibrating alarm (where fitted)	36
4.3.4 Resetting an Alarm	37
4.4 Fault and Warning Condition	37
4.4.1 Warning	37
4.4.2 Fault condition	38
4.5 Safelink	38
4.5.1 What is Safelink?	38
4.5.2 Using Safelink	39
4.6 PUMP (IMPACT PRO ONLY)	42
4.6.1 Removal of the Pump Adaptor	47

---

## CONTENTS

---

Section	Page	
4.7	Menus	47
4.7.1	Flammable Gas Selection	48
4.7.2	Operator	49
4.7.3	Calibration	50
4.7.4	Instrument Details	50
4.7.5	Safelink	51
4.7.6	Language	51
4.8	Datalogging	51
4.8.1	Installing the PC Software	52
4.8.2	Event Datalogging	52
4.8.3	Gas Datalogging (optional)	53
4.8.4	Output Formats	53
4.9	Calibration	54
4.9.1	Contaminants	54
4.9.2	Flow Calibration – Instrument	56
4.9.3	Flow Calibration – PC	61
4.9.4	Enforcer Calibration	62
5.	FAULT FINDING AND PROCEDURES	64
6.	ACCESSORIES	65
6.1	Basestation	65
6.2	Basestation Plinth	66
6.3	Basestation PSU Link Cable	66
6.4	Offline Trickle Charger	67
6.5	Power supply for Basestation and Trickle Charger	67
6.6	Enforcer	68
6.7	Enforcer gas cylinder	68
6.8	Flow adaptor	69
6.9	Metal Belt Clip	69
6.10	Instrument Webbing Clip	69
6.11	Body Harness Kit	70
6.12	Pump Adaptor Kit	70
6.13	10m Sample Tube Kit	70
6.14	Earpiece	71
6.15	Basestation PC Link Cable	71

## CONTENTS

Section	Page
6.16 Safelink Cable Assembly	71
6.17 Safelink Cable Restraint Clip	72
6.18 Hand Aspirator Kit	72
6.19 Sensing Probe 1m	73
6.20 Ball float	73
7. ROUTINE MAINTENANCE	74
7.1 Cleaning	74
7.2 Filters	74
7.3 Battery charging / replacement	75
7.3.1 Rechargeable Battery Pack	76
7.3.2 Dry cell	77
8. ROUTINE SERVICING	78
8.1 Serviceable Cartridges	78
9. SPARE PARTS	96
10. GLOSSARY	97
11. APPENDIX A	101
11.1 Warning Codes	101
11.2 Fault Codes	104
12. APPENDIX B	106
12.1 Warranty	106
12.2 Certification Approvals	106
12.2.1 DMT Test Report	107
12.2.2 Safelink Connection Drawing	110
12.3 Technical Specifications	111
12.3.1 Instrument Specification	111
12.3.2 Charger Specifications	112
12.3.3 Specific Speed of Response Data (Rising Gas Levels)	113
12.3.4 Specific Recovery Time Data (Falling Gas Levels)	114

# INSTRUMENT LABELS

## EQUIPMENT LABEL

An explanation of the information on the equipment label is shown below.

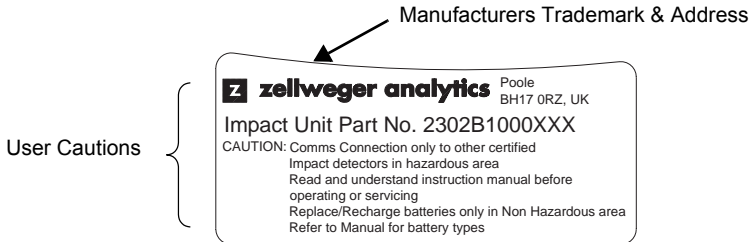

## CENELEC (ATEX) CERTIFICATION LABEL

An explanation of the information on the Cenelec (ATEX) certification label is shown below.

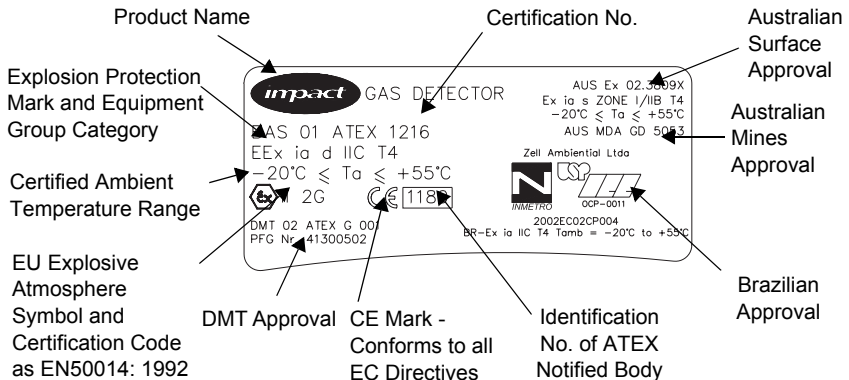

---

## INSTRUMENT LABELS

---

This instrument has been assessed by DMT for performance of Oxygen, Methane, Propane, Carbon Monoxide, Hydrogen Sulfide and Carbon Dioxide channels.

The label marking indicates this:

DMT 02 ATEX G 001  
PFG Nr. 41300502

The instrument has been tested in accordance to the following European Standards.

- EN50054 & EN50057: 1998 for Combustible Gases (Methane and Propane).
- EN61779-1: 2000 for Combustible Gases (Methane and Propane) and EN61779-4: 2000.
- EN50104: 1998 for the measurement of Oxygen.
- EN45544-1 & EN45544-2: 1999 for the measurement of Carbon Monoxide, Hydrogen Sulfide and Carbon Dioxide.
- EN50271: 2000 for the assessment of Digital Components and Software.

### **WARNING**

Assessment has only been made in the range of 0 to 100%LEL. Use of other ranges of flammable gas measurement on this instrument will invalidate this approval.

---

## INSTRUMENT LABELS

---

### UL / CSA CERTIFICATION LABEL

An explanation of the information on the UL / CSA certification label is shown below.

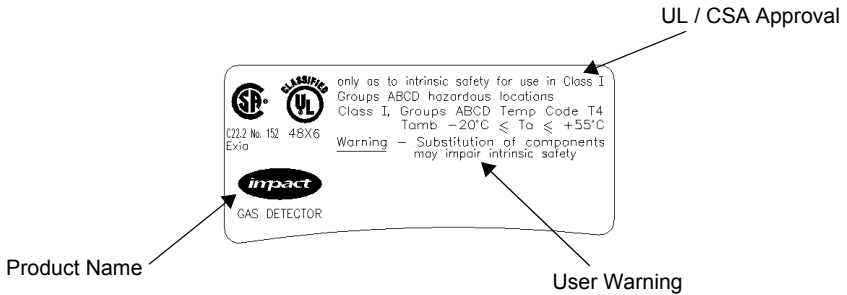

### WARNING

Only the combustible gas detection portion of this instrument has been assessed by CSA for performance. Furthermore assessment has only been made in the 0 to 100 %LEL scale. Use of other ranges of flammable gas measurement on this instrument will invalidate approval.

---

# 1. INTRODUCTION

---

The Impact / Impact Pro is a compact, portable gas monitor designed to be carried or worn without hindering the user. Its purpose is to monitor the atmosphere continuously for hazardous levels of up to four gases. These concentrations of gases are measured using Zellweger Analytics sensors. Audible and visual alarms alert the user to danger when hazardous conditions are detected.

The instrument is usually supplied with four gas sensors, for detecting oxygen (enrichment and deficiency), flammable gases (up to the Lower Explosive Limit) and two toxic gases (for personal safety) all housed in an easily replaceable cartridge.

Various sensor technologies are used to achieve this. In the vast majority of cases, electrochemical technology is used to detect oxygen and toxic gases while catalytic combustion technology is used to detect flammable gases.

Two types of cartridge are available. One is disposable where the cartridge has a fixed life and once this has expired the cartridge is disposed of. The other is a Serviceable Cartridge where the sensors can be individually replaced when required. The serviceable cartridge type can only be used in the Impact Pro.

*Note: Throughout this manual it is assumed that the Impact / Impact Pro is equipped with a Disposable Four Sensor Gas Cartridge. References to sensors not fitted in the users instrument should be ignored.*

*This manual covers all models - some features are not available on all models. Not all models are available in every country.*

The instrument is supplied with dry cells and holders as standard. Rechargeable batteries and charger can be purchased separately as a kit.

---

# 1. INTRODUCTION

---

## 1.1 INTENDED USE

The Impact/Impact Pro has been designed to alert the user to potentially hazardous atmospheres whilst carrying out his/her normal duties. Therefore, the instrument must be kept switched on and worn as close to the breathing area as possible, and several accessories are provided to allow the instrument to be worn in a number of different ways:

- a. On the chest
- b. On a belt
- c. Attached to a body harness

The instrument is provided with various methods to enable the user to comply safely and easily with confined space regulations.

### CAUTIONS

Hand aspirated remote sampling only provides continuous gas readings as long as the bulb is being operated.

Zellweger Analytics recommend that the instrument be calibrated at least every 6 months or in accordance with customer site procedures, whichever is sooner. Correct operation of the instrument should be confirmed with test gas of known concentration before each use.

The use of **Enforcer** calibration accessory is strongly recommended as it enables this to be performed quickly and easily.

### WARNING

A sensor which cannot be calibrated or which is found to be out of tolerance should be replaced immediately. For the disposable cartridge a replacement cartridge must be fitted.

## 1.2 PRODUCT OVERVIEW

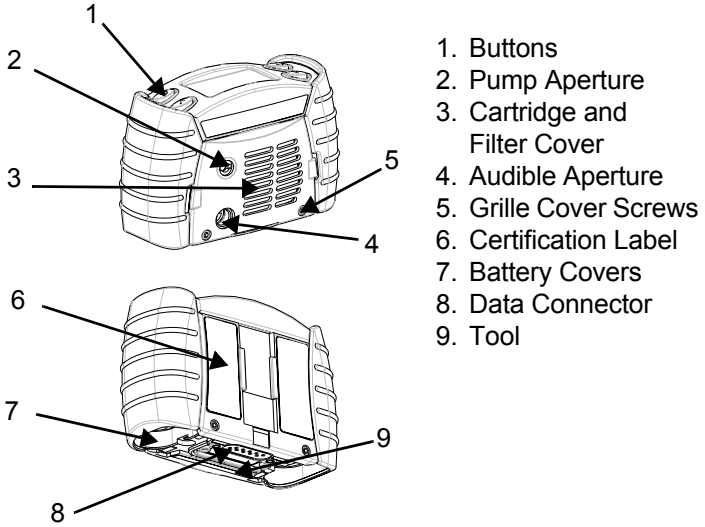

On the top of the unit are four buttons (1). Their functions are summarised below:

▲ (yellow) Moves up through menu screens, and used to increase values

✓ (green) used as 'OK' in menus. Accepts alarms, and resets peak values

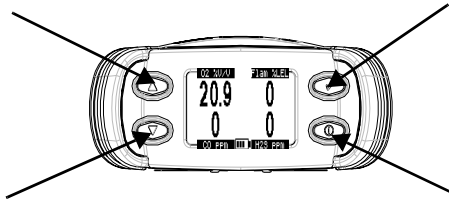

▼ (yellow) Moves down through menu screens, and used to decrease values

Ⓜ (red) On/Off button. Also used as 'change' in menus.

Pressing any key will automatically activate the display backlight for 10 seconds.

---

## 1. INTRODUCTION

---

There are currently two types of instrument available - Impact and Impact Pro. The main differences between the two instruments is that the Impact Pro supports a range of Serviceable Cartridges (see Section 8.1 *Serviceable Cartridges* of this manual). The other detail differences are the addition of an internal sample pump, vibrating alarm and Safelink feature.

The instrument can be further personalised by use of the Impact Configuration Utility (ICU) PC software, which can be purchased separately as part of the Data Logging Kit. This allows the user to change various settings and features of the instrument including, but not limited to Alarm Levels, Autozero function, latching alarms, vibrating alarm (where fitted), data logging settings and Safelink messages.

---

## 2. GETTING STARTED

---

### 2.1 HOW TO TURN IMPACT/IMPACT PRO ON AND OFF

The Impact has been designed for ease of use, and especially for one-handed operation - only a single button is needed to turn it on and off.

- To turn the instrument on, press the ① button until the instrument activates its audible and visual alarms. It will follow the start-up sequence described in Section 3. *INSTRUMENT START-UP.*

If the instrument displays an error that no cartridge is fitted then follow the procedure in Section 2.2 *Inserting the cartridge.*

- To turn the instrument off, press and hold the ① button for three seconds, until it switches off. Note that on some models a password must be entered to switch the unit off. Failure to enter the correct password will cause the instrument to continue as though the ① button had not been pressed.

---

## 2. GETTING STARTED

---

### 2.2 INSERTING THE CARTRIDGE

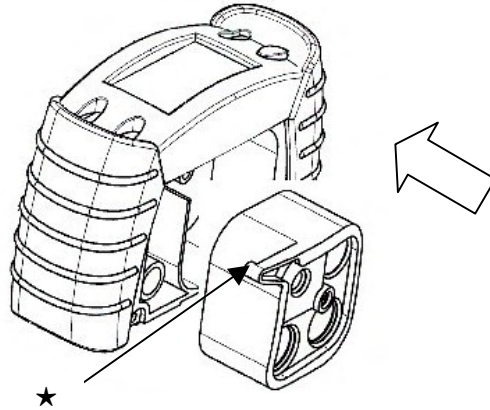

- (1) If the instrument is switched on then switch it off by pressing and holding the  $\text{\textcircled{1}}$  button. **Note:** if a cartridge is already fitted, check that the instrument clock is correct. If it is not, change the instrument clock as described in section 4.1.1.
- (2) Undo the two grille cover screws (5).
- (3) If a cartridge is already fitted then remove it by undoing the central screw.
- (4) Insert new cartridge into aperture as shown. Ensure that the point '★' is located correctly in the pump or moulding (depending on model).
- (5) Gently tighten up the central screw to secure in place.
- (6) Check the condition of the filter on the grille cover (3), and if necessary, replace it.
- (7) If the unit is fitted with a pump replace the pump seal.

---

## 2. GETTING STARTED

---

- (8) Replace the front cover, and retighten the two screws (5).
- (9) Wait at least 20 minutes. Then switch the Impact on by pressing the ① button and check no faults are reported by the instrument. If fault 4 occurs refit the cartridge.
- (10) Once the new cartridge is fitted the instrument will compare it to the cartridge fitted previously. The instrument will alert the user with warning if:
  - a) the alarm levels are different
  - b) the number of sensors is different
  - c) the mix of the sensors is different.
- (11) If the instrument reports a gas alarm, switch instrument off, wait 20 minutes, and switch unit on again.

### 2.3 CHARGE FOR FIRST USE

Either a rechargeable battery pack or a dry-cell battery source can power the Impact. For the rechargeable battery it must be charged before first use, to replace any battery capacity used during transit and storage.

- (1) Ensure the basestation is connected to a suitable power source.
- (2) Place the instrument in the basestation.

The basestation employs a locking mechanism to ensure that the Impact is retained under most operating conditions. To ensure this operates correctly the following procedure should be followed:

---

## 2. GETTING STARTED

---

- a) Ensure that the Impact is orientated such that the instrument lip will be inserted under the locking lip.

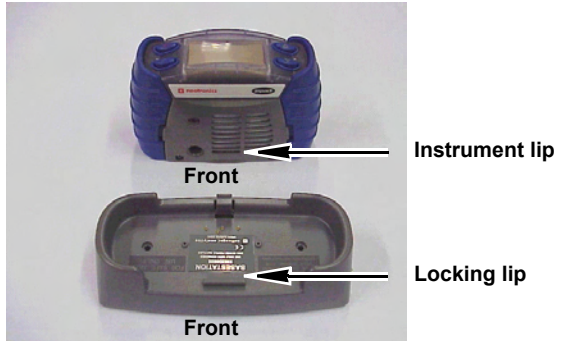

- b) Insert the front of the Impact at an angle such that the instrument lip slides under the locking lip.

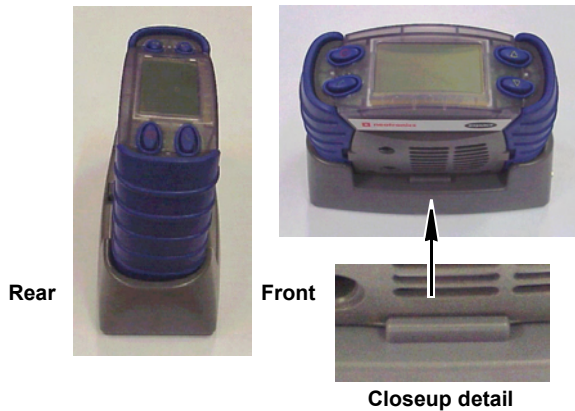

---

## 2. GETTING STARTED

---

- c) Push down on the rear of the Impact such that the rear locking catch engages.

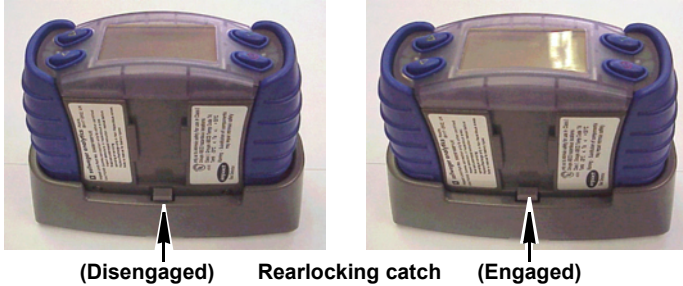

- d) To remove the Impact press down on the rear locking catch.

All 4 alarm lights will flash indicating the Impact has started charging.

- (3) Whilst charging the instrument, the instrument will flash 2 red LEDs approximately every 2 seconds. When charging is complete it will light the green LEDs constantly. A pair of fully discharged battery packs will require 7 hours to recharge fully.

### **WARNING**

Do not charge the battery pack in a hazardous area.

---

## 2. GETTING STARTED

---

### 2.4 DRY-CELL BATTERY INSERTION

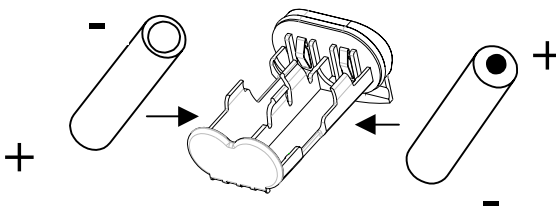

- (1) Undo the two battery compartments (7) using the tool (9) provided, on the bottom of each instrument.
- (2) Release each dry-cell battery holder and remove the cells if fitted.
- (3) Insert new cells, ensuring correct orientation by checking that the negative terminal is at the same end as indicated on the moulding. Ensure they are of the correct type, to comply with the intrinsic safety requirements.
- (4) Replace dry-cell holders in the battery compartments, and retighten cover screws.
- (5) Instrument is now ready for use.

---

## 2. GETTING STARTED

---

### 2.5 SAMPLING

In normal operation the Impact is worn on the belt, with its harness, or held by hand. Once turned on the Impact monitors the atmosphere continuously, which reaches the sensors by diffusing through the vents of the grille cover or by being pulled through by the internal pump (if fitted). For non-pump instruments normal air movements are sufficient to carry the sample to the sensors, and the sensors react immediately to changes in concentrations of the gases being measured in the atmosphere immediately surrounding the detector. Depending on your application and the options fitted to the instrument the environment can be sampled remotely in a variety of ways, as summarised below:

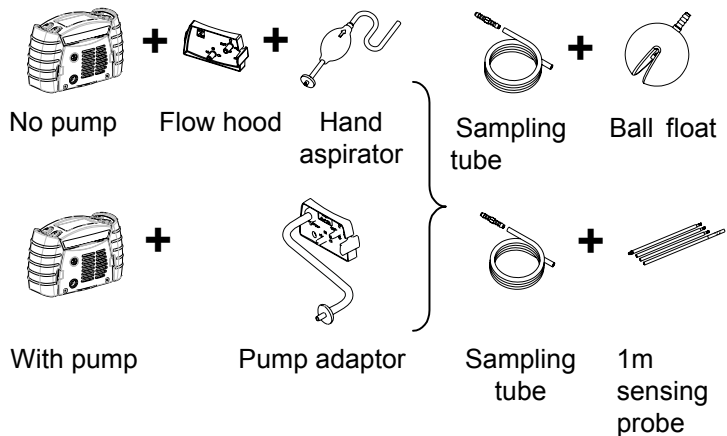

---

## 2. GETTING STARTED

---

### CAUTIONS

Hand aspirated remote sampling only provides continuous gas readings while the bulb is being squeezed. Each time a reading is required, it is necessary to squeeze the bulb at a rate of one per second until the readings remain stable.

When using the built-in pump ensure that the sampling tube is not inserted into a fluid.

---

## 3. INSTRUMENT START-UP

---

### 3.1 INSTRUMENT INFORMATION

After turning the instrument on it will display the information in the following autosequence (depending on model):



The first display identifies the model. Whilst this is shown the alarms are tested, If a vibrating alarm is fitted this is also activated. Whilst this screen is displayed, pressing the  $\text{\textcircled{1}}$  button will cause the instrument to identify the version of software installed and the instrument serial number.



A Language Selection Screen is then shown (first use only). Use the  $\blacktriangle$  and  $\blacktriangledown$  buttons to highlight the required language and press the  $\checkmark$  key to make the selection. Note that some of the languages may be 'off screen' - use the  $\blacktriangle$  and  $\blacktriangledown$  buttons to access these.



The language can be changed at a later time, if required. See section 4.7.6 for details.

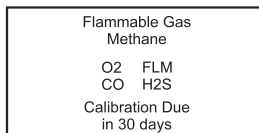

The display then shows the gas that the flammable sensor is set to monitor, the sensors fitted and when the calibration is due (if the calibration is due in less than 30 days).

---

## 3. INSTRUMENT START-UP

---

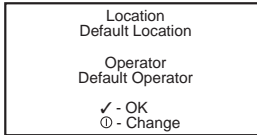

The instrument logs data on the operator's exposure, if any, to measured toxic gases. It achieves this by requesting the operator to confirm his/her identity and the location where the instrument is being used. The screen displays the last location and operator. If these are acceptable then press the ✓ button. Otherwise select a new location and/or operator.

### 3.2 SELECTING LOCATION / OPERATOR

To change the location and/or operator press the Ⓢ button and the display will show the current location. Press the ▲ and ▼ buttons to cycle through the list. Once the correct location has been found then press ✓, and follow the same procedure to select the operator.

### 3.3 FRESH AIR AUTO ZEROING SENSORS

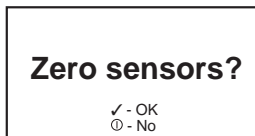

If enabled the instrument will prompt if you wish to zero the sensors in fresh air, to adjust for any natural drift that may have occurred. If the ✓ button is pressed the instrument will then ask the user to ensure that it is being zeroed in fresh, uncontaminated air.

---

## 3. INSTRUMENT START-UP

---



If the ✓ button is pressed the instrument will zero the sensors automatically, and display whether the procedure was successful. The oxygen reading will be adjusted to 20.9%v/v – the other sensor readings will be adjusted to 0 ppm and 0%lel appropriately. If the ⊙ button is pressed instead the instrument will use its current zero values instead and proceed to the monitoring screen.

*Note: This is a 'soft' zero. Any adjustments only remain in force whilst the instrument is switched on. To permanently adjust the zero, the zero via the calibration menu must be used ('hard zero').*

### 3.4 SENSOR WARM-UP PHASE

Following display of the Autozero screen it will be noted that the message 'Cell Self Test Please Wait' is displayed. This is displayed while the sensors are in the warm-up phase of the start-up procedure. If the option of Autozero is declined the main gas measuring screen will be displayed with the message 'Warm Up' being displayed in place of the gas concentration readings. The instrument should not be used until the 'Warm Up' message has disappeared. The amount of time that the sensors are in warm up will depend on the sensor type. Table 12.3.1 in section 12 of this manual gives details of the warm up times for each of the sensors.

## 4. OPERATION

*Note: Wherever the manual says 'select', the procedure is to use the ▲ and ▼ buttons to cycle through the list, and then press ✓ to select the required option.*

### 4.1 MONITORING CONDITION

#### 4.1.1 Display Screens

With no alarm conditions the display will typically show:

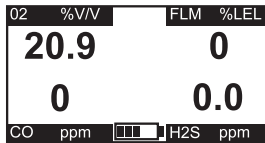

The gas sensors and their respective units are displayed, complete with a battery gauge monitor at the bottom. For an instrument fitted with less than four sensors each unused sensor position will show '---'.

Several data screens are available and these can be viewed by pressing the ▲ and ▼ buttons to cycle through. The symbol in the centre of the screen will identify which screen is active.

Peak Screen ( ▲ )

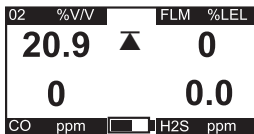

This symbol is displayed when the instrument is displaying the peak readings for the sensors, i.e. the highest readings seen since the instrument was switched on or since they were reset. This is useful for pre-entry checks for confined space entry. These readings can be reset by pressing the ✓ button whilst this display is shown.

This screen will alternate with a screen showing the minimum value of oxygen. In this case the ▲ is replaced by ▼.

---

## 4. OPERATION

---

### STEL Screen ( )

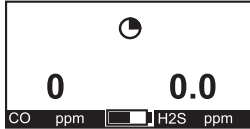

This symbol is displayed when the instrument is displaying the STEL readings for the toxic sensors. The STEL is a time weighted average, measured over a 15 minute reference period. It is used to monitor exposure to toxic gases in line with current regulations and/or legislation. Until 15 minutes has elapsed these are projected values.

### LTEL Screen ( )

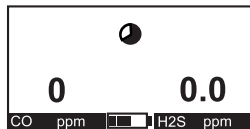









This symbol is displayed when the instrument is displaying the LTEL (TWA) readings for the toxic sensors. The LTEL is a time weighted average, measured over an 8 hour reference period. It is used to monitor exposure to toxic gases in line with current regulations and/or legislation. Until the Impact has been monitoring continuously for 8 hours these are projected values.

### Status Screen



This screen shows the current time, date and battery status.

It is possible to change the instrument clock setting as follows: Press the  key while this screen is displayed and the clock setting function will be activated, with the hour field highlighted. Use the  and  keys to change the value as required and press the  key to move to the minute field. Again use the  and  keys to change the value and continue until all of the fields have been correctly set. Finally press the  key to store the changes. Note that the  key can be pressed at any time to abort the procedure.

---

## 4. OPERATION

---

### 4.1.2 Other Displayed Symbols

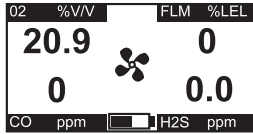

If the pump is operating correctly the pump symbol will rotate.

If the pump flow becomes blocked the instrument will warn the user and stop the pump to prevent potential damage. When the user accepts the warning message the instrument will attempt to restart the pump. There is no need to remove and refit the Pump Adaptor. At this point, the user should investigate the cause of the blockage alarm. If the blockage is cleared then the pump will successfully restart. If the blockage is still present then the instrument will again warn the user that the pump flow is still blocked. This will repeat until the blockage is removed.



This shows an approximation of the remaining battery capacity within the instrument. If there is less than 20 minutes remaining battery life then the instrument will display a 'Low Battery' warning.



This will be shown instead of the numerical reading for any sensor or channel that is faulty, if a zero or span calibration has failed, in instances of low oxygen and in some cases of high gas concentrations. Switch the instrument off and then back on. If this does not clear the fault then recalibrate the sensor or change the cartridge.

---

## 4. OPERATION

---

**-0**

This indicates that the sensor output of the indicated channel has drifted negative. In severe cases of sensor negative drift, a Warning 51 (Excessive Negative Drift) will be shown. Please see Appendix A – Warning Codes for further details on this warning message.

### **WARNING**

If -0.0 Vol.% for the CO<sub>2</sub> sensor channel is permanently displayed, a sensor zero (during boot procedure) or a zero calibration needs to be performed in clean air. The alarm level A1 for the CO<sub>2</sub> range must not exceed 0.5 Vol.%.

#### **4.1.3 Confidence Signal**

To ensure correct operation the instrument monitors itself and will confirm correct operation by giving an audible and green visual confidence signal once every 30 seconds. The confidence signal is given when the instrument is able to detect gas (for example the confidence signal will not be given during pump or sensor calibration phases, or if the sensors are in warm-up).

There is a configurable option to silence the audible confidence signal but the visual confidence signal will still operate. If the instrument is in a low battery condition the confidence signal will occur twice every 30 seconds.

*Note: The audible confidence signal is the primary indication that the instrument is functioning correctly. It is therefore strongly recommended that this feature not be disabled.*

#### **4.1.4 Go/No Go Option**

A configurable option is available which replaces the numeric values with a ✓ symbol when everything is OK and ✗ when there is or has been an alarm or fault, as shown below. All alarms operate as normal, but other functions and menus are disabled.

---

## 4. OPERATION

---

This display now also shows the battery capacity as follows.

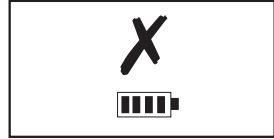
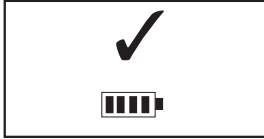

The Go / No Go Option is configured using the Impact Configuration Utility (ICU) PC software from the Configuration Screen.

### 4.2 ATMOSPHERIC ALARM CONDITIONS

#### CAUTION

The Impact portable gas detector has been designed for the detection of oxygen deficiencies and enrichments, flammable gas and toxic gas levels. An alarm condition indicating the presence of one or more of these potentially life-threatening hazards should be taken seriously.

In the event of an alarm is activated when the measured gas concentration exceeds the pre-set alarm point.

A rapid increase in reading followed by a declining or erratic reading may indicate a hazardous combustible gas concentration that exceeds the measuring range of the Impact (i.e. greater than 100%LEL or 5.0%v/v Methane). In the event of the instrument being exposed to a very high level of flammable gas the following behaviour will be noted.

- Warning 54 (Low O<sub>2</sub>) and an alarm condition will be indicated. This warning will be latched.
- Warning 52 (sensor over-range) and an alarm condition will be indicated.
- The flammable reading will be latched to 100%LEL or 5.0%v/v Methane with an alternating cross on the channel.

For other sensors reading greater than the measurement range, '▲▲▲' will be displayed.

---

## 4. OPERATION

---

### 4.3 ALARM CONDITION

There are two modes of alarm: latching and non-latching. However, the display will give the same alarm indication:

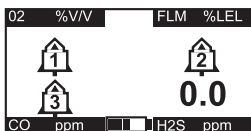

An alarm symbol will appear in the relevant section of the display. The alarm symbol contains a number, indicating the increasing severity of the alarm, with increasing frequency of the audible and visual alarms. If there is a STEL/LEL alarm the relevant icon will appear and flash.

Any alarm will cause the backlight to be switched on automatically.

#### 4.3.1 Latching Alarms (default)

In the latched condition, once an alarm occurs both audible and visual alarms continue to operate even after the atmospheric hazard has cleared. Pressing any of the instrument buttons will clear an alarm. Any subsequent alarm will reactivate the audible and visual alarms.

#### 4.3.2 Non-latching Alarms

In this mode, should a gas alarm occur the instrument would enter an alarm condition. When the readings return to normal levels the audible and visual alarms will stop.

#### 4.3.3 Vibrating alarm (where fitted)

If this option is fitted to the instrument any alarm condition that activates the audible and visual alarms will also activate the built-in vibrating alarm.

---

## 4. OPERATION

---

### 4.3.4 Resetting an Alarm

If an alarm condition occurs it is possible to cancel the alarm by pressing any of the buttons, once the gas measurements have returned to a safe level. Otherwise, the instrument will remain in the alarm condition, but the audible alarm will be muted. Any subsequent alarms that occur 1 second after the previous alarm has been reset will reactivate the audible alarm.

### 4.4 FAULT AND WARNING CONDITION

In addition to the gas alarms, the Impact includes a number of auxiliary alarms to safeguard proper use of the instrument. At switch on the Impact performs an electronic self-test that assures the user of proper performance. When the Impact detects that an electronic fault or failure condition has occurred, the audible and visual alarms are activated and an explanatory message will be displayed.

#### CAUTION

As the Impact is designed to protect from potentially life-threatening atmospheric conditions, any alarm conditions must be taken seriously.

#### 4.4.1 Warning

##### WARNING

Code - 0  
See manual

The instrument displays a warning message for situations where a fault or error has occurred but may be resolved by the user.

The 'Code - 0' shown here is an example only. A full list of codes is given in Appendix A.

---

## 4. OPERATION

---

### 4.4.2 Fault condition



If a fault condition is detected during start-up or subsequently, the instrument will display a fault message warning the user and giving a contact number. This will remain until the instrument is turned off by pressing the ① button for at least 3 seconds.

The 'Code - 0' shown here is an example only. A full list of codes is given in Appendix A.

### 4.5 SAFELINK

#### 4.5.1 What is Safelink?

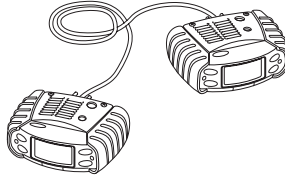

Safelink is a confined space entry communication system between instruments, fitted with the Safelink feature. It allows one instrument (the 'attendant') to display the gas readings measured by the other connected instrument (the 'entrant'), up to a maximum cable length of 100m. Safelink also provides an automatic timed response system requiring the Entrant's instrument to return a signal, activated by the entrant, within a user-specified time interval. Failure of the user to respond will cause an alarm to be raised on the Attendant's instrument. Additionally, any continued pressing on any button on the entrants instrument at any time will cause an 'Emergency' message to appear on the attendant instrument - similar to the action of a panic button. In Safelink mode the entrant instrument can neither be switched off, nor can the pump

---

## 4. OPERATION

---

feature (where fitted) be used on either instrument. It will be found that while the pump is running the Safelink option on the instrument menu system has been removed. Furthermore, if an attempt to start the pump is made (on either the attendant or entrant instrument) during Safelink operation an alarm condition is generated and Safelink Mode has to be exited.

Safelink mode cannot be entered when the batteries are low (i.e. there is less than 1 bar on the battery indication meter).

In some instances a Fault or Warning will not be displayed on the Entrant instrument. In this case it is important to note that gas alarms on the Entrant instrument are still indicated on the Entrant and the Attendant instruments.

### 4.5.2 Using Safelink

Connect the Safelink cable between two instruments. Turn on each instrument and from the user menu on each instrument select the Safelink mode.





On one instrument select Attendant. When selecting the Attendant on one instrument the instrument will display 'locating' while it attempts to connect with the other instrument. Once established each instrument will briefly display 'Configuring'. The instrument will then show the readings – ensure that the Safelink symbols appear on the display. To check the integrity of the communications it is recommended that a message be sent from the Attendant to the Entrant. Whenever a message must be responded, the instrument will flash its green LEDs and sound its audible alarm at a rate of once per second.

Until the Safelink cable is disconnected both instruments will remain in Safelink mode.

## 4. OPERATION

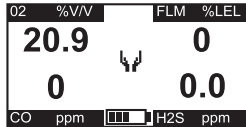
### 4.5.2.1 Attendant Instrument



The instrument will display the readings being monitored on the Entrant instrument. The  symbol is used to indicate the Attendant's instrument. When the symbol is static it indicates that Safelink communications are occurring. When it is flashing the Safelink has become disconnected and the readings will all show '---', until the link is restored or the user exits from Safelink mode. All display modes from the Entrant's instrument (peak, STEL, etc) are available to the Attendant.

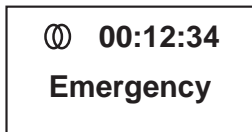

The status screen shows the duration that Safelink has been in operation, and the status of the connection as either Normal, Emergency, or Link failure.

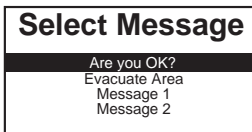

By pressing the  button the Attendant has access to a menu, to select a message to send to the Entrant. These are configurable using the PC software.

The Select Message menu gives access to two additional actions:

- Emergency, which immediately issues a 'Get Out' warning to the Entrant.
- Exit, to enable termination of the Safelink without removing the cable.

---

## 4. OPERATION

---

### 4.5.2.2 Entrant instrument

The symbol  is used to indicate the Entrant's instrument. When the symbol is static it indicates that Safelink communications are occurring. When it is flashing the Safelink has become disconnected.

Only the instantaneous values are shown, although all alarm conditions will operate as normal.

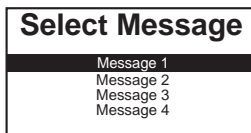

By pressing the ✓ button the entrant has access to a menu, to select a message to send to the attendant. These are configurable using the PC software, and could be used to indicate work progress, e.g. 'Valve Now Closed'.

### 4.5.2.3 Timed Response

At a preselected interval the attendant's instrument will prompt for the Entrant to be checked. The Entrant must press any button within a preselected time, otherwise the Safelink system will assume an emergency situation has occurred and raise alarms on both instruments. The default interval is 5 minutes. The default time to respond to a message is 30 seconds. Both of these can be changed using the PC software.

### 4.5.2.4 Terminating Safelink



To terminate Safelink mode the cable should be disconnected between the instruments. Both instruments will display a menu enabling Safelink mode to be switched off.

---

## 4. OPERATION

---

Safelink mode must be terminated before attempting to use the instrument in a basestation (for charging or calibration) or the Enforcer.

### 4.6 PUMP (IMPACT PRO ONLY)

The pump allows gas to be drawn through tubing across the sensors. Fitting the Pump Adaptor will automatically switch the pump on.

If the pump is operating correctly the pump symbol will rotate.

Please refer to Section 4.1.2 *Other Displayed Symbols* of this manual on the operation of the instrument under blocked flow conditions.

The instrument contains a feature that tests and if necessary dynamically sets the Pump Stall threshold via a calibration routine. Upon fitting the Pump Adaptor, the user will see the following sequence of screens. The instrument gives instructions at each stage informing the user as to what operations need to be performed.

Please follow the instructions on screen during the Pump Test and Calibration procedure. Fit the required length of sample tube of the inlet of the Pump Adaptor together with the Hydrophobic Filter. Fit the Pump Adaptor to the front of the instrument.

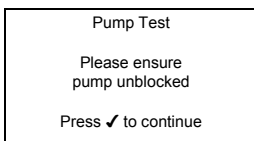

Ensure that there is nothing obstructing the flow into the sample pump and press the ✓ button.

---

## 4. OPERATION

---

The following screen will be displayed briefly.

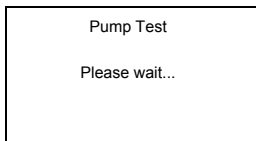

Followed by...

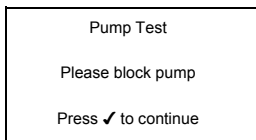

Use a suitable method to block the end of the sample tube and press the ✓ button.

The instrument will now test the pump. Ensure that the blockage is kept in place for the duration of this test.

If the pump test is successful the following screen will be displayed.

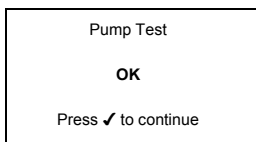

Remove the blockage from the sample tube and press the ✓ button.

The internal sample pump feature is now ready for use.

To stop the sample pump, remove the Pump Adaptor as described in Section 4.6.1 *Removal of the Pump Adaptor*.

If the Pump Test fails then the pump calibration procedure will start.

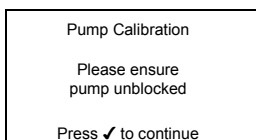

---

## 4. OPERATION

---

Ensure that there is nothing obstructing the flow into the sample pump and press the ✓ button.

The instrument will then perform the first part of the pump calibration.

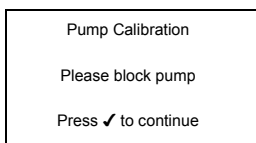
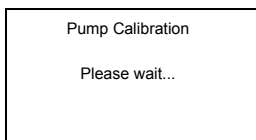

Use a suitable method to block the end of the sample tube and press the ✓ button. The pump calibration will now commence.

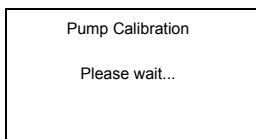

Ensure that the pump is kept in a blocked state until the following screen is displayed.

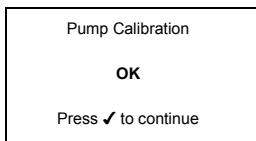

Remove the blockage from the sample tube and press the ✓ button.

The internal sample pump feature is now ready for use.

## 4. OPERATION

If the Pump Calibration fails (please see the diagnostic table at the end of this section) then use of the sample pump is inhibited. The Pump Adaptor must be removed from the instrument and the fault investigated. To correctly remove the Pump Adaptor, follow the instructions in section 4.6.1.

Removal of the Pump Adaptor will turn the pump off.

Below 0°C the efficiency of the pump will be adversely affected, requiring a longer sampling time.

The following is a list of possible problems that could cause the instrument to fail the various tests detailed in this procedure.

Symptom	Possible Cause	Remedy
The instrument reports 'Pump Test Fail'	The sample pump is in an uncalibrated state or the operating conditions of the pump have changed significantly since the last calibration.	Perform the Pump Calibration to recalibrate the pump.
	The pump was not blocked correctly when required.	Remove the Pump Adaptor and refit to restart the test. Ensure that the pump is blocked correctly when instructed to.
	A blocked condition was not detected within 30 seconds of the start of the test.	Remove the Pump Adaptor and refit to restart the test. Ensure that the pump is blocked as soon as the 'Please block pump screen' is displayed.

## 4. OPERATION

Symptom	Possible Cause	Remedy
The instrument reports 'Pump Calibration Fail'	The pump was not blocked correctly when required.	Remove the Pump Adaptor and refit to restart the test. Ensure that the pump is blocked correctly when instructed to.
	There is a leakage in the system.	Check that the following items are correctly fitted and/ or are not damaged. <ul style="list-style-type: none"> <li>• Pump Seal (behind front cover)</li> <li>• Sample Tube</li> <li>• Pump Adaptor</li> </ul>
	A blocked condition was not detected within 30 seconds of the start of the test.	Remove the Pump Adaptor and refit to restart the test. Ensure that the pump is blocked as soon as the 'Please block pump screen' is displayed.
	The Pump Assembly is faulty.	Request a new Pump Assembly or contact Zellweger Analytics for assistance.
PUMP FAULT and WARNING 16 'Pump Fault' screens are displayed following the Pump Calibration.	The Pump Calibration has failed.	Remove the Pump Adaptor and investigate the fault (see The instrument reports 'Pump Calibration Fail' above).

---

## 4. OPERATION

---

### 4.6.1 Removal of the Pump Adaptor

To ease the removal of the Pump Adaptor, follow the steps below.

- (1) Support the end of the Pump Adaptor close to the inlet port using the thumb of one hand.
- (2) Press on the top of the clip using the thumb of the other hand until a click is heard.
- (3) Lift the Pump Adaptor clear of the instrument.

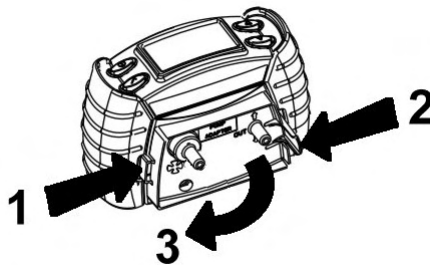

### 4.7 MENUS

While the gas monitoring screen is displayed, pressing the ✓ button will provide access to menus, depending on the model.

User Menu
Flammable
Calibration
Operator
Instrument
Safelink
Language

*Note: Calibration is not permitted until the sensors have warmed-up and been self tested or if the pump is running. If you access the user menu under any of these circumstances the Calibration option will not be available.*

## 4. OPERATION

### 4.7.1 Flammable Gas Selection

It is possible to set the display to read for specific flammable gases. Select the required flammable gas. The instrument will automatically adjust its internal correction factors.

Note that for:

EN50054 100 %LEL Methane = 5.0 %v/v

EN61779 100 %LEL Methane = 4.4 %v/v

#### 4.7.1.1 Flammable Cross-Sensitivity Table

Flammable Gas	EN50054 Relative Sensitivity (% of Methane Reading)	EN61779 Relative Sensitivity (% of Methane Reading)
Hydrogen	125	142
<b>Methane</b>	<b>100</b>	<b>100</b>
Ethylene	91	88
Methanol	83	95
Ethane	90	85
Ethanol	67	71
Propane	68	66
Butane	56	59
Pentane	56	63
Octane	42	47

*Note: The above data are applicable only to instruments that are configured to display the Flammable gas in %LEL.*

The above table and the cross-sensitivity feature offered in the Impact and Impact Pro are supplied for indicative purposes only. The following points should be noted when using the table or the software feature.

- (1) There is variability in sensor cross-sensitivity between methane and other flammable compounds. Therefore, if

## 4. OPERATION

the instrument is calibrated to Methane (including Enforcer calibrations), the reading when other Flammable gases are selected will be subject to variation.

- (2) For more accurate detection of non-Methane gases, the Flammable Channel of the instrument should be calibrated to Propane, Pentane or Butane (selectable from the Settings option in the Calibration Menu). In this instance the reading obtained when Methane is selected may be subject to inaccuracy.
- (3) Maximum accuracy will be obtained by calibrating with the target gas, and is therefore the preferred method.

Target Gas	Recommended Calibration Method
Methane	Enforcer
	UI Calibration (using Methane as the selected calibration gas)
	PC Calibration (using Methane as the selected calibration gas)
Propane	UI Calibration (using Propane as the selected calibration gas)
	PC Calibration (using Propane as the selected calibration gas)
Butane	UI Calibration (using Butane as the selected calibration gas)
	PC Calibration (using Butane as the selected calibration gas)
Pentane	UI Calibration (using Pentane as the selected calibration gas)
Other flammable gases	UI Calibration (using Propane, Butane or Pentane as the selected calibration gas)
	PC Calibration (using Propane or Butane as the selected calibration gas)

### 4.7.2 Operator

This allows a new operator and/or location to be selected without restarting the instrument.

## 4. OPERATION

### 4.7.3 Calibration

See Section 4.9 *Calibration* for full details.

### 4.7.4 Instrument Details

Several screens are available detailing the instrument set-up, such as alarm levels. These can be viewed by pressing the ▲ and ▼ buttons to cycle through them. Some examples are shown below and these are indicative only. Information shown will vary according to model, country, product application and / or specific requirements.

Software Revision Version 2.6
Serial Number 0000000000
Calibration Due in 34 days

This information is also available at switch-on of the instrument (see section 3.1 for details).

02	%V/V	FLM	%LEL
23.0	↑	A1	10
19.0	↓	A2	20
18.0	↓	A3	50
Flammable Gas Methane			

These are the alarm level settings for oxygen and flammable sensors. There are no associated STEL or LTEL alarms for these sensors. ↑ indicates a rising alarm and ↓ indicates a falling alarm.

35	↑	A1	10.0	↑
400	↑	A2	40.0	↑
500	↑	A3	50.0	↑
200		STEL	10.0	
30		LTEL	5.0	
CO	ppm	H2S	ppm	

This shows the alarm levels for the toxic sensors.

The following displays indicate whether particular options are fitted and how the instrument is currently configured.

Pump Fitted  Data Logging Event  Safelink Fitted	Last Calibration 1 Jan 2001  Autozero Enabled  Gas Alarms Latched	Battery Rechargeable  Vibrating Alarm Enabled  Language English
-----------------------------------------------------------------------	----------------------------------------------------------------------------------------	--------------------------------------------------------------------------------------

---

## 4. OPERATION

---

The following additional information is also displayed:

Cartridge SN 0001138	Cartridge Type Standard
Date of Manufacture 25/Jun/2001	Install By 26/Dec/2001
Boot ROM Version Impact Boot 1.4+	Date of Activation 9/Aug/2001

### 4.7.5 Safelink

For Impact Pro instruments the additional menu for Safelink is available. It is used to initiate communication via Safelink to another Impact Pro instrument.

The Safelink option (where applicable) will not be available in the following situations.

- When the internal sample pump is running.
- When the batteries are low (i.e. there is less than 1 bar on the battery indication meter).

### 4.7.6 Language

The Impact is supplied pre-loaded with English, French, German, Italian, Spanish and Dutch languages, which can be selected using the ▲, ▼ and ✓ keys of the instrument. In addition one other alternative language can be uploaded to the Impact (currently available are Portuguese, Danish, Swedish, Norwegian and Finnish) using the Impact Configuration Utility (ICU) PC software, which is supplied separately.

## 4.8 DATALOGGING

There are two types of datalogging. In both cases the information is accessed by downloading it to a computer using the PC software, which is supplied as part of the Datalogging Kit. The PC software enables this data to be downloaded,

---

## 4. OPERATION

---

stored, printed and analysed. The data can be exported in a format suitable for use with major spreadsheet software packages. The datalog memory can be automatically cleared after a successful download – note that this will not change any of the alarm levels, instrument settings, or calibration gas settings or values of the instrument. An internal battery will retain the data for 5 years even if the instrument battery is disconnected or the instrument is switched off. Refer to Section 4.8.1 on how to install the PC software.

### 4.8.1 Installing the PC Software

- (1) Insert the CD into your CD-ROM drive. If the CD autoruns press the Esc key to stop.
- (2) From the Start menu, choose Run.
- (3) In the Run dialog box, type d:\English\ setup.exe, where d is the letter assigned to your CD-ROM drive.
- (4) Click OK, then follow the instructions on your screen.

### 4.8.2 Event Datalogging

All instruments are supplied complete with event datalogging. This records the time and date whenever an event occurs. When the datalogging memory is full then the earliest data is overwritten. In event mode the datalogging memory can store at least 500 events. An event can be:

- Instrument switch on
- Instrument switch off
- Peak gas reading whilst switched on
- Any gas alarm (A3, A2, A1, STEL, LTEL)
- Low battery
- Fault

---

## 4. OPERATION

---

### 4.8.3 Gas Datalogging (optional)

Set-up by the PC software for instruments fitted with this full datalogging option it enables the instrument to monitor areas for gas, sampling either at a regular interval (for instance, every 15 seconds) or when the readings change by a user-selected difference.

This extended datalogging can also store the event logging information if required.

### 4.8.4 Output Formats

The calibration history, event logging and gas logging are output in a CSV (Comma Separated Variable format) with the file extension '.txt'. To view the information in Microsoft Excel®, follow these steps:

- (1) Open the file using Microsoft® Excel. Note that the 'Files of Type' box must be set to 'All files' to show the files, which have a '.txt' extension.
- (2) Excel will recognise the format as 'delimited text' and start up a 3 step 'Text Import Wizard'.
- (3) For step 1 select 'Delimited'. Then press 'Next'.
- (4) For step 2, in the Delimiters box, ensure Tab and Commas are enabled. Then press 'Next'.
- (5) For step 3, ensure Column Data Format is 'General'. Then press 'Finish'.
- (6) The data will now be shown in consecutive columns, and can be saved, printed and analysed as required.

To create a file, which can be opened directly from Windows Explorer simply by double-clicking on it, change the file extension to '.csv' before downloading and saving the file.

---

## 4.9 CALIBRATION

The accuracy of the Impact instrument must be functionally checked with known concentration calibration gas before each day's use. If any sensor fails recalibrate the Impact before using, or replace the cartridge. It is recommended that the instrument be calibrated at least every 6 months.

The Impact instrument provides three methods of calibration, offering flexibility for the user. Flow calibration is the traditional method and can be performed, following instructions displayed on the instrument itself (Section 4.9.2 *Flow Calibration – Instrument*), or when the instrument is connected to a PC via a basestation, on the PC display (See Section 4.9.3 *Flow Calibration – PC*). An alternative method for instruments fitted with a combination of oxygen, flammable, carbon monoxide and hydrogen sulfide sensors only is to use the **Enforcer** accessory. For all other gases the flow calibration method must be used.

### CAUTIONS

Use of non-standard calibration gas and/or calibration components when calibrating the Impact can lead to dangerously inaccurate readings.

The calibration should be carried out in a well-ventilated area to avoid contaminants.

#### 4.9.1 Contaminants

Oxygen sensors may be affected by prolonged exposure to carbon dioxide, and it is recommended the Impact not be subjected to use in atmospheres containing more than 25%v/v carbon dioxide (CO<sub>2</sub>). Oxygen sensors may read high in the presence of carbon dioxide.

## 4. OPERATION

Flammable sensors may be affected by exposure to Silicone substances; organic phosphorus containing compounds and halogenated organic compounds. Although the flammable sensors used in Impact and Impact Pro have a high resistance to Hydrogen Sulfide (H<sub>2</sub>S) poisoning some loss in sensitivity should be expected. Therefore it is strongly recommended repeated gassing with H<sub>2</sub>S or gas alarms on the H<sub>2</sub>S channel should be followed by checking and if necessary re-calibration of the Flammable sensor. The sensors on average will lose approximately 20% of their sensitivity when subjected to forty applications of H<sub>2</sub>S for a period of 1 minute each.

The toxic sensors are designed to be gas specific, minimising the effects of common cross-interfering gases. The table below summarises the effect of various gases on the Carbon Monoxide and Hydrogen Sulfide sensors.

Applied Gas	H <sub>2</sub> S Response (ppm)	CO Response (ppm)
Acetone (1000ppm)	0	0
Acetylene (40ppm)	0	80
Ammonia (50ppm)	0	0
Carbon Monoxide (50ppm)	0	50
Carbon Dioxide (5000ppm)	0	0
Chlorine (0.5ppm)	0	0
Ethanol (2000ppm)	0	3
Ethylene (100ppm)	0	85
Hydrogen (100ppm)	0	20
Hydrogen Sulfide (10ppm)	10	0
Iso-Propanol (200ppm)	0	0
Nitric Oxide (25ppm)	0	4
Nitrogen Dioxide (3ppm)	0	0.5
Sulfur Dioxide (2ppm)	0	0

#### 4.9.2 Flow Calibration – Instrument

The following equipment is required:

- cylinder of calibration gas (either certified individual gas per sensor or a certified multi-gas mixture)
- flow adaptor: ensure that the tubing is fitted to the port marked 'IN' (except for Cl<sub>2</sub> cartridges where the tubing should be fitted to the port marked 'OUT').
- flowmeter/regulator set to 300ml/min
- tubing

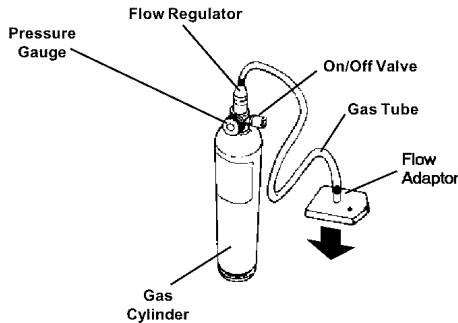

To put the instrument into calibration mode the menus are accessed. If configured it may be necessary to enter a password before access to calibration is possible.

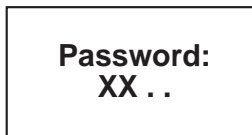

The keys must be pressed in the correct sequence, otherwise the password will be rejected. As each key is entered the '.' will be replaced by 'X'.

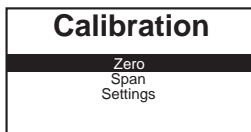

The calibration procedure requires a zero, followed by a span. The span requires specific concentration of calibration gas that matches those held in the settings. Select the required option.

---

## 4. OPERATION

---

When performing a flammable span gas concentration the instrument will assume the use of the gas selected. However, after calibration it will revert to the flammable gas that the instrument is set to measure. No intervention by the user is required.

*Note: For Methane or Propane calibrations the following conversion should be used.*

*EN50054 100%lel Methane = 5.0%v/v*

*EN50054 100%lel Propane = 2.0%v/v*

*EN61779 100%lel Methane = 4.4%v/v*

*EN61779 100%lel Propane = 1.7%v/v*

*If other values are required, adjustment of the calibration point should be carried out as detailed in Section 4.9.2.2 Span of this manual.*

### 4.9.2.1 Zero

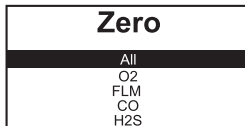

The display will show the sensors fitted in the cartridge, and offer the option to 'hard' zero an individual channel or all four simultaneously. O<sub>2</sub> is automatically highlighted.

Assuming flammable is selected by pressing the ▼ and ✓ keys, the display will show:



The zero must be performed in fresh, uncontaminated air. Alternatively, a supply of compressed air with an oxygen content of 20.9%v/v can be used.

---

## 4. OPERATION

---

After pressing the ✓ button the instrument will display the following whilst zeroing the sensor.



Once the zero is complete the instrument will display whether the zero was successful.



or



If the zero was unsuccessful repeat the zero ensuring that the instrument is in fresh air. If a second failure occurs the cartridge should be changed. After a successful zero a span should be performed.

### 4.9.2.2 Span

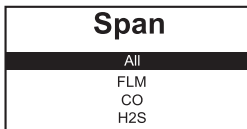

The display will show the sensors fitted in the cartridge, and offer the option to span an individual channel or three simultaneously using a gas mix.

Having selected the gas the display will change to show:



## 4. OPERATION

Ensure that the Span Calibration Setting matches that of the gas concentration being applied. If not, press the  $\odot$  button to change the setting.

The following table gives the current set allowable range of Span Gas Concentrations.

Gas Type	Allowable Range
Methane	20%LEL to 100%LEL
Carbon Monoxide	80ppm to 500ppm
Hydrogen Sulfide	15ppm to 50ppm
Carbon Dioxide	0.5%v/v to 3.0%v/v
Chlorine	2ppm to 10ppm
Ammonia	10ppm to 100ppm
Sulfur Dioxide	5ppm to 20ppm

Ensure that the correct concentration of the gas is available. If not then press the  $\odot$  button to change the settings.

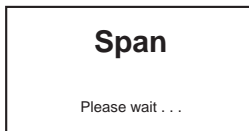

After pressing the  $\checkmark$  button the instrument will display this message whilst spanning the sensor.

Once the span is complete the instrument will display whether the span was successful.



or



If the span was unsuccessful repeat the span ensuring that the calibration gas used is of the correct concentration, there is sufficient gas in the cylinder and that the flow rate is correct.

---

## 4. OPERATION

---

### 4.9.2.3 Calibration Gas Settings

#### WARNING

Verify that the concentration printed on the label of the calibration gas cylinder that will be used is the same as the concentration shown on the calibration gas settings screen. Using the wrong concentration may cause incorrect adjustment during calibration procedures, and lead to dangerously inaccurate readings during normal operation.

Settings	
<b>FLM:</b>	50 %LEL
CO:	100 ppm
H2S:	40.0 ppm

Select the channel to change. The highlighted channel settings can then be altered using the ▲ (increase) and ▼ (decrease) buttons, holding the buttons down to change the setting more rapidly. Press ✓ to store the new settings value.

Assuming flammable is chosen the instrument will request which calibration gas is being used, irrespective of what the instrument is set to measure.

Select Gas
Methane
Propane
Butane
Pentane

Zellweger Analytics recommends the following calibration gas concentrations:

Flammable (%LEL Measurement) :50%lel Methane  
Flammable (%VOL Measurement):2.5%v/v Methane  
Carbon Monoxide: 100ppm  
Hydrogen Sulfide: 40ppm  
Carbon Dioxide: 2.0 %v/v

---

## 4. OPERATION

---

Cartridges manufactured before 1/2/2002 have the following calibration gas limits:

	<b>Minimum</b>	<b>Maximum</b>
Flammable (%lel):	25%	100%
CO:	100ppm	500ppm
H <sub>2</sub> S:	15ppm	50ppm
CO <sub>2</sub> :	0.5% v/v	3.0% v/v

Cartridges manufactured after 1/2/2002 have the following calibration gas limits:

	<b>Minimum</b>	<b>Maximum</b>
Flammable (%lel):	25%	100%
Flammable (%vol):	1.2%	5.0%
CO:	80ppm	500ppm
H <sub>2</sub> S:	15ppm	50ppm
CO <sub>2</sub> :	0.5% v/v	3.0% v/v

Performing a manual calibration using settings lower than these specified minima will result in a calibration failure.

### 4.9.3 Flow Calibration – PC

For this function the user will require the Impact Configuration Utility (ICU) PC software, serial cable, Base Station and Power supply. These items can be purchased as part of the DataLogging kit (available separately).

Place the Impact into the basestation and ensure that there is power connected. Switch the Impact on, and then follow the instructions on the computer.

The instrument will display the readings whilst the calibration process is occurring and the  symbol will be displayed in the centre of the display.

The software is designed to be easy to use and has its own manual and online help.

---

## 4. OPERATION

---

Information, such as gas cylinder serial numbers, can also be entered for traceability. Also, calibration reports can be printed.

### 4.9.4 Enforcer Calibration

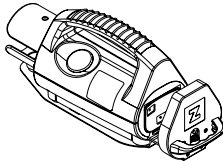

This is designed for oxygen, flammable, carbon monoxide and hydrogen sulfide, using a special-to-type gas cylinder. It offers quick, simple and safe operation by any user, due to the use of a patented low pressure, low flow rate system.

Note that the Enforcer cylinder contains dangerous gases.

The instrument is switched on and the autozero procedure performed. If the instrument was 'hard zeroed' (using the zero on the calibration menu) prior to a successful Enforcer calibration the unit will automatically update the next calibration required by 180 days. If the unit was only 'soft zeroed' (autozero during switch on) prior to a successful Enforcer calibration the unit will not adjust the next calibration date. If the Enforcer calibration fails then no adjustments are made whether a hard or soft zero was performed.

The instrument, when placed correctly into the Enforcer, will recognise it and will prompt the user to press the ✓ button

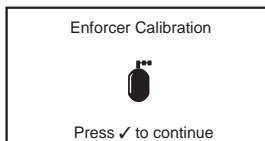

The instrument will then control the calibration process. The user should hear the distinctive 'click' of the Enforcer gas

---

## 4. OPERATION

---

delivery solenoid valve. After completion, the instrument will display whether calibration was successful.

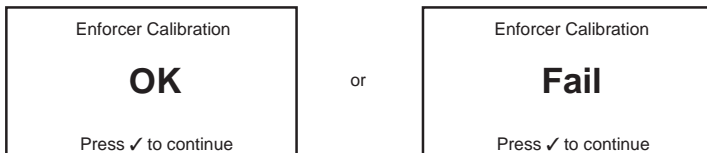

Remove the instrument from the Enforcer. If the Enforcer calibration failed repeat the process. If it fails again return the instrument for a calibration under controlled conditions or replace the cartridge.

The instrument automatically reverts to a flammable gas setting of methane whilst in use with the Enforcer. On completion it will revert to the flammable gas that the instrument is set to measure. No intervention by the user is required.

---

## 5. FAULT FINDING AND PROCEDURES

---

There are two levels of fault within the instrument.

The first level is a warning, from which the user may be able to recover, e.g. a low battery. The user must press the ✓ button to confirm the warning has been seen.

The second level is usually non-recoverable by the user, and in some cases the only action available is to switch the instrument off.

In both cases a warning/fault code number is given with a brief description of the fault, and a contact name/telephone number to enable the user to further assistance if required. Details of the warning and fault codes are given in Appendix A.

---

## 6. ACCESSORIES

---

### WARNING

DO NOT ATTEMPT TO CHARGE THE BATTERY PACK IN THE HAZARDOUS AREA.

The following accessories are available for use with Impact/Impact Pro.

### 6.1 BASESTATION (Part Number: P2302B0800)

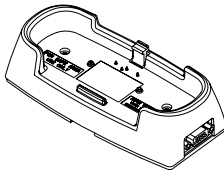

This unit provides a smart charging facility for instruments powered by rechargeable NiMH batteries. The instrument is simply inserted into the base station whereby it is fast charged. The instrument controls the charging process and will indicate when it is fully charged, and then change to a trickle charge mode to keep the battery topped up until the instrument is required.

The basestation also provides a facility to connect the instrument to a PC, for downloading of logged data, viewing or changing instrument configuration information, or as a means of instrument calibration.

Ensure that the instrument is not inserted backwards into the basestation. Firstly locate the lip at the front of the instrument into the corresponding recess, and then latch the rear catch. To release pull back the rear catch (see Section 2.3 *Charge for first use*).

If the instrument is switched on whilst placed in the basestation the instrument will not reach full capacity (typically only 85% if switched on for the entire fast charge period).

---

## 6. ACCESSORIES

---

The basestation accepts an input of 12Vdc to 32Vdc.

Basestations may be daisy-chain linked. See Section 6.3 *Basestation PSU Link Cable*.

### 6.2 BASESTATION PLINTH (Part Number: P2302B0804)

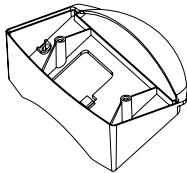

The basestation can also be mounted desk-mounted or vertically, singly or stacked using the optional plinth. To mount the basestation vertically remove the base plate and rotate. To mount in a vehicle remove the base plate to reveal two mounting holes, for screwing the basestation to the vehicle bodywork or suitable framing.

### 6.3 BASESTATION PSU LINK CABLE (Part Number: 2302D0821)



Allows basestations to be linked together, to a maximum of 5, minimising cabling and power sockets, and forming a multibank charger.

Due to the potential variety of applications and installations Zellweger Analytics do not supply such power supplies. The requirements are 12Vdc to 32Vdc, rated at 500mA per basestation.

### WARNING

The standard Power Supply unit must not be used when connecting multiple Base Stations. Overheating of the Power Supply and ultimately failure will result.

---

## 6. ACCESSORIES

---

### 6.4 OFFLINE TRICKLE CHARGER

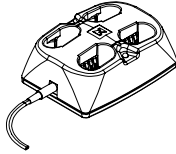

Permits off-instrument charging of 2 or 4 instrument battery packs in 14 hours. It enables 24 hour availability of rechargeable instruments with purchase of additional battery packs.

Battery packs must be charged in pairs. The trickle charger is supplied with the required mains PSU.

The red LED indicates the batteries are receiving charge. Please note that the battery packs must be charged in pairs, and may be left inserted indefinitely until required.

Power Supply	Part Number
230Vac 50Hz Euro plug format	2302B0730
230Vac 50Hz UK plug format	2302B0731
120Vac 60Hz USA plug format	2302B0732
240Vac 50Hz Australian plug format	2302B0733

### 6.5 POWER SUPPLY FOR BASESTATION AND TRICKLE CHARGER

A range of suitable power adaptors is available to power the base station and trickle charger:

	Power Supply	Part Number
1	230Vac 50Hz Euro plug format	2302D0816
2	230Vac 50Hz UK plug format	2302D0818
3	120Vac 60Hz USA plug format	2302D0819
4	240Vac 50Hz Australian plug format	2302D0820
5	12V/24VDC vehicle charger lead	2302D0815

---

## 6. ACCESSORIES

---

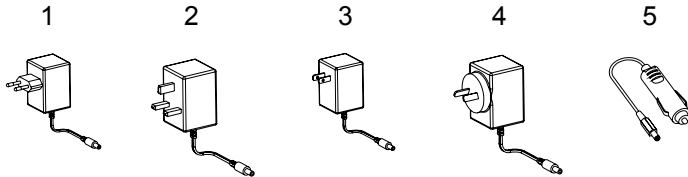

### CAUTION

These individual Power Supplies will only supply power to one Basestation or one Trickle Charger.

### 6.6 ENFORCER (Part Number: 2302B0831)

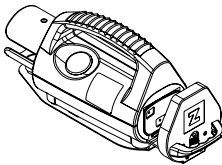

This test and calibration accessory is only for use with instruments fitted with any combination of oxygen, flammable, carbon monoxide and hydrogen sulfide sensors. Its operation is described in Section 4.9.4 *Enforcer Calibration*. This is supplied complete with an Enforcer disposable, multigas cylinder.

For EMC/RFI Enforcer is tested to EN50270 Light Industrial Type 2.

### 6.7 ENFORCER GAS CYLINDER (Part Number: 2302D0833)

The Enforcer requires a gas cylinder with pre-set concentration values, and a specific valve to maintain the required low pressure and flow rate, which enables the Enforcer to operate quickly and simply.

---

## 6. ACCESSORIES

---

### 6.8 FLOW ADAPTOR (Part Number: P2302B0810)

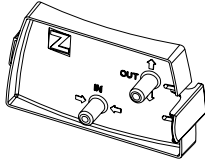

Allows aspirator to be fitted to the instrument. It is also used when calibrating using the instrument or the PC. It is coloured grey to differentiate it from the pump adaptor. See Section 6.12 *Pump Adaptor Kit*.

### 6.9 METAL BELT CLIP (Part Number: P2302D0826)

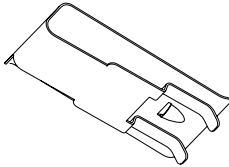

Supplied as standard. Enables the instrument to be worn on a belt.

### 6.10 INSTRUMENT WEBBING CLIP (Part Number: P2302B0382)

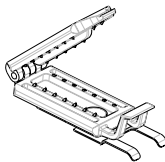

Allows the instrument to be clipped to harness webbing.

---

## 6. ACCESSORIES

---

### 6.11 BODY HARNESS KIT (Part Number: P2302B0822)

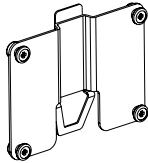

Simply clips onto the rear of the instrument. Allows the instrument to be worn on the chest within the breathing zone. Comes with a waist strap and neck strap.

### 6.12 PUMP ADAPTOR KIT (Part Number: 2302B0814)

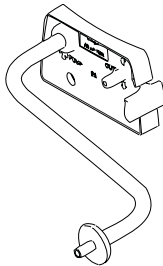

When plugged into the pump aperture (2) of an instrument fitted with the pump, the pump will be automatically activated by the instrument. Subsequent removal of the adaptor will switch the pump off. This maximises the battery life of the instrument, as well as prolonging the life of the pump in the instrument. It is coloured black to differentiate it from the flow adaptor. See Section 6.8 *Flow adaptor*.

### 6.13 10M SAMPLE TUBE KIT (Part Number: 2302B0828)

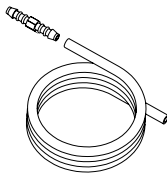

Extends the sampling reach of the instrument, and can be used hand aspirator or Pump Adaptor Kit. Supplied with a coupler it can be extended beyond 10m (30') by purchasing additional kits. The maximum recommended length is 20m and the sample time should be adjusted accordingly.

## 6. ACCESSORIES

### 6.14 EARPIECE

(Part Number: 2302B0841)

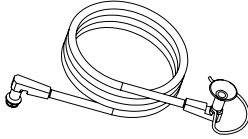

For noisy environments the earpiece plugs into the audible aperture (4), to allow any audible alarms or signals to be heard. The vibrating alarm if fitted will still operate. The instrument audible alarm produces a high sound level. Caution should be exercised when using the earpiece.

### 6.15 BASESTATION PC LINK CABLE

(Part Number: P2302D0807)

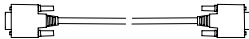

This is supplied to connect the basestation to a standard 9-pin D-type RS232 serial port on a PC or laptop, running the PC software.

### 6.16 SAFELINK CABLE ASSEMBLY

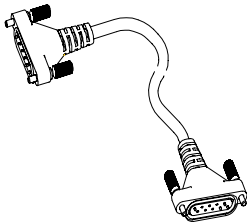

This is available in 4 different lengths and allows Safelink enabled instruments to be connected together for communications, as described in Section 4.5 *Safelink*.

10m (33') + 2 x Cable Restraints	2302B0735
30m (100') + 2 x Cable Restraints	2302B0736
50m (150') + 2 x Cable Restraints	2302B0737
100m (300') + 2 x Cable Restraints	2302B0746

2302B0746 is supplied with a cable reel and an adaptor.

---

## 6. ACCESSORIES

---

### 6.17 SAFELINK CABLE RESTRAINT CLIP (Part Number: P2302B0713)



Clips the Safelink cable to a belt to provide a strain relief.

### 6.18 HAND ASPIRATOR KIT (Part Number: 2302B0813)

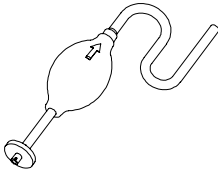

Clips onto the flow hood to provide manual aspiration.

The bulb should be squeezed at a rate of one per second, until a stable reading is obtained. As a guideline, the following sample tube lengths will require:

Length m (approx ft)	Sampling Time (seconds)
1 (3)	15
5 (15)	20
10 (30)	25
15 (50)	30
30 (100)	40

---

## 6. ACCESSORIES

---

### 6.19 SENSING PROBE 1M (Part Number: 2302B0847)

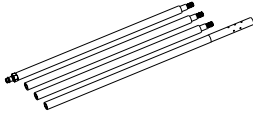

Used with the bulb operated hand aspirator or the internal pump if fitted, it allows sampling from above normal height areas or into areas of low accessibility. Ensure that the sections of the sampling probe are tightened to prevent dilution of the sample.

### 6.20 BALL FLOAT (Part Number: 2302B0846)

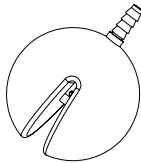

Clips to the end of the sampling tube being used, and provides the dual function of preventing liquid entering the instrument and also breaking the surface tension of any liquid to release trapped gas.

The Impact/Impact Pro is designed to operate almost maintenance free under most conditions, except for the need for regular calibration. However, it is recommended that on a regular basis the instrument is cleaned and the filters changed.

## **7.1 CLEANING**

The instrument may need cleaning if exposed to dirty or hostile conditions. This can be easily achieved by wiping over with a damp cloth. Do not use bleaching products or products containing silicon compounds as these can cause damage to the sensors.

## **7.2 FILTERS**

The Goretex filter fitted under the grille cover is manufactured from a water repelling material to protect the sensors from the ingress of water and other contaminants. The life of this filter is dependent on the amount of dust and viscous liquids in the atmosphere. If it becomes dirty (discoloured) it will act as a barrier and prevent the diffusion of the atmosphere onto the sensors, and must be replaced. This is easily achieved by removing the grille cover screws (Section 1.2 *Product overview* (5)), discarding the old filter and fitting a new filter, using the moulded detail to locate it.

Note that for instruments fitted with a chlorine sensor a stainless steel filter (part number P2302D0823) must be used instead of the Goretex filter.

---

## 7. ROUTINE MAINTENANCE

---

### 7.3 BATTERY CHARGING / REPLACEMENT

#### WARNING

Battery Charging and replacement must not be carried out in a hazardous or potentially dangerous area.

A mixture of dry cell and rechargeable battery packs must not be used - the instrument safety system prevents operation in such a situation, and the instrument displays a fault message and activates the audible and visual alarms.

If the instrument is fitted with a CO<sub>2</sub> Cartridge, please refer to the instructions in Section 8 – *Charging Procedure for Impact Pro fitted with CO<sub>2</sub> Variant Cartridges*.

#### INFORMATION

To maintain peak battery performance Zellweger Analytics strongly recommend that the batteries be periodically (every 4 to 6 months) fully discharged before recharging. To do this, remove the Impact from the Base Station (if fitted) and switch the Impact on. Leave the Impact to run until it switches off. This may take up to 12 hours depending on the state of charge of the batteries. A Warning 14 (Battery Low) will be generated towards the end of this procedure, which can be acknowledged or ignored. Once the Impact has switched off, fit it into the Base Station and allow the instrument to fully recharge before next use.

In severe cases (e.g. when the instrument has not been used for some time) it may be necessary to repeat this 2 or three times to restore peak battery performance.

---

## 7. ROUTINE MAINTENANCE

---

### INFORMATION

Should the batteries in the Impact instrument become excessively discharged (e.g. when unused for some time) there may be occasions when the alarm LEDs and sounder will operate when attempting to switch the instrument on before recharging. In this instance please place the instrument into the powered Base Station and switch the instrument off when Fault 23 is displayed. The Impact will then proceed to charge as normal.

### 7.3.1 Rechargeable Battery Pack

### CAUTION

The rechargeable battery packs are sealed units. Do not attempt to remove the cells from the packs as this will invalidate the safety certification.

Battery packs can be recycled by returning to the nearest Zellweger Analytics Appointed Distributor.

Remove the battery packs if the instrument will not be used for some time.

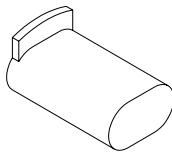

The basestation accessory is used to charge rechargeable battery packs, provided it is powered from an appropriate power supply source. The instrument is simply placed in the basestation, which charges the packs under the control of the instrument.

When first placed in the basestation all four red LEDs will briefly light, to indicate charging will occur.

Whilst charging, two of the red LEDs will flash at a slow rate. Once fully charged the red LEDs will be switched off and the green LEDs will be constantly lit.

---

## 7. ROUTINE MAINTENANCE

---

If the instrument is switched on when it is placed in the basestation the charging progress will be displayed on the instrument.

If a dry-cell instrument is inadvertently placed in the basestation no damage will occur due to a built-in safety system.

In the event that the rechargeable battery packs needs to be replaced or the dry-cell adaptors are to be used to power the instrument, the battery cover screws (see Section 1.2 *Product overview*) are released using the built-in tool (see Section 1.2 *Product overview*) and the sealed units removed. Replacement rechargeable packs are inserted into the compartments and the covers replaced.

The full fast charge time for a pair of fully discharged battery packs is 7 hours indicated by two of the red alarm LEDs flashing approximately every 2 seconds. After this period the instrument will trickle charge the battery packs indefinitely shown by the green LEDs being constantly illuminated.

### 7.3.2 Dry cell

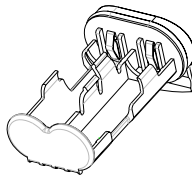

If dry cells are to be used the specific adaptors must be used to comply with certification. Ensure the orientation of the individual cells is correct, and that they are all of the following types:

**Duracell MN1500**

**Energizer Intelligent E91.**

### **WARNING**

Use of any other dry-cell battery will render the intrinsic safety approval of the instrument void.

---

## 8. ROUTINE SERVICING

---

Apart from the maintenance described in Section 7. *ROUTINE MAINTENANCE* the servicing requirements are limited to:

- Calibration
- Changing of the cartridge when required or indicated by the instrument
- Replacing sensors in serviceable cartridges (i.e. non-OFCH combinations where supported by the instrument)

### 8.1 SERVICEABLE CARTRIDGES

Instruments that support serviceable cartridges can have the individual sensors replaced, instead of replacing the whole cartridge.

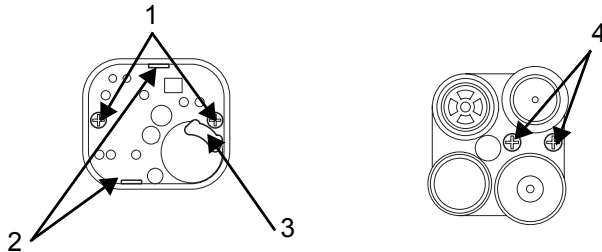

The procedure is as follows:

- (1) Switch the instrument off and remove the front cover.
- (2) Unscrew the central cartridge screw and remove the cartridge.
- (3) On the underneath undo the two screws (1).
- (4) Lever out the PCB from the locating tabs (2), on the two sides adjacent to the screws. Retain the sensor retainer (3) if fitted.
- (5) Pull out the PCB.

---

## 8. ROUTINE SERVICING

---

- (6) For all sensors except the oxygen, replacing the sensor requires the user to unplug the existing sensor and locate the new sensor in the same position.

Please note that CO<sub>2</sub> sensors are supplied on a PCB, which must be removed before fitting the sensor to the cartridge.

- (7) For the oxygen sensor the two screws (4) must be undone. The tabs of the replacement sensor must be securely screwed to headers. Ensure each sensor tab is secured to the correct header.
- (8) Replace the PCB in the housing, until it clicks into place.
- (9) Replace the two screws (1), ensuring the retainer is fitted (3) and insert the cartridge into the instrument.
- (10) Check the front cover membrane and if necessary replace it.
- (11) Replace the front cover and wait at least 20 minutes. Then switch the instrument on.
- (12) The instrument must be calibrated before use.

---

## 8. ROUTINE SERVICING

---

### Special Notes for Cl<sub>2</sub> Cartridges

It is important that you read all of the notes below before installation or use of your new cartridge.

#### Installation of your Cl<sub>2</sub> Cartridge

*Note: Cartridge Installation or Replacement must never be carried out in a hazardous area.*

- (1) If a cartridge was previously fitted to the Impact into which the Cl<sub>2</sub> cartridge is to be installed, remove the Front Cover Grille using the Allen Key provided in the bottom of the Impact. Unscrew the fixing in the centre of the cartridge and lift the cartridge from the Impact.
- (2) Place the Cl<sub>2</sub> cartridge into the Impact and screw the cartridge fully home using the Allen Key. Guide the cartridge if necessary using your fingers to ensure that it is seated correctly.
- (3) Replace the Pump Seal with the one provided with your cartridge.
- (4) Remove the existing Filter Assembly from the inside of the Front Cover Grille by peeling it away. Take the Stainless Steel Filter assembly (supplied in the Cartridge Kit) and remove the protective backing paper. Locate the Filter assembly onto the locating pegs on the inside of the Front Cover Grille and lightly press around the edge of the gasket to secure.
- (5) Replace the Front Cover Grille and refit the Allen Key into the bottom of the Impact.
- (6) To complete installation of the cartridge allow at least 20 minutes before operating the Impact.
- (7) After this period of time switch the Impact on and accept the New Configuration when prompted to do so.

---

## 8. ROUTINE SERVICING

---

### Using your Cl<sub>2</sub> Cartridge

Please ensure that the following points are noted when the cartridge is in service.

- (1) Always use PTFE tubing (maximum length of 500mm) and a flow rate of 500ml/min when calibrating the Cl<sub>2</sub> channel.
- (2) Apply all gases to the port marked OUTLET (not INLET) on the Flow Housing.
- (3) With regard to the actual sensors fitted, please perform span calibrations on the sensors of the Impact cartridge in the following order: Cl<sub>2</sub>, NH<sub>3</sub>, H<sub>2</sub>S, CO, Flammable.
- (4) When performing a Span Calibration on the Cl<sub>2</sub> channel it is good practice to flow Cl<sub>2</sub> calibration span gas through connected tubing for a minimum of 15 minutes **without the flow adapter fitted to the Impact** before attempting a span calibration. Failure to do so may result in a false calibration of the Cl<sub>2</sub> channel.
- (5) Do not apply Span Calibration gas to the Impact for greater than 5 minutes. Again failure to do so may result in a false calibration of the Cl<sub>2</sub> channel.
- (6) This cartridge is not suitable for pumped mode operation.
- (7) Due to the open nature of the Stainless Steel filter, there is a greater risk of water damage occurring to the instrument. Every attempt should be made to keep the instrument dry.

## 8. ROUTINE SERVICING

- (8) Refer to the CAUTIONS given in section 1.1 of this manual for details on recommended daily checks on your gas detector.

<i>Applied Gas</i>	<i>Effect on CO Sensor</i>	<i>Effect on H<sub>2</sub>S Sensor</i>	<i>Effect on CO<sub>2</sub> Sensor</i>	<i>Effect on Cl<sub>2</sub> Sensor</i>	<i>Effect on NH<sub>3</sub> Sensor</i>	<i>Effect on SO<sub>2</sub> Sensor</i>
CO (100ppm)	100ppm	0ppm	0%v/v	0ppm	35ppm	1ppm
H <sub>2</sub> S (40ppm)	0ppm	40ppm	0%v/v	-25ppm <sup>1</sup>	50ppm	1ppm
CO <sub>2</sub> (0.5%v/v)	0ppm	0ppm	0.5%v/v	0ppm	0ppm	TBA
Cl <sub>2</sub> (5ppm)	0ppm	0ppm	0%v/v	5ppm	0ppm	-2ppm <sup>1</sup>
NH <sub>3</sub> (50ppm)	0ppm	0ppm	0%v/v	-2ppm <sup>1</sup>	50ppm	TBA
Hydrogen (1000ppm)	200ppm	0ppm	0%v/v	TBA	35ppm	TBA
SO <sub>2</sub> (10ppm)	0ppm	0ppm	0%v/v	2ppm	0ppm	10ppm

<sup>1</sup> Reading displayed as -0ppm.

---

## 8. ROUTINE SERVICING

---

### Special Notes for NH<sub>3</sub> Cartridges

It is important that you read all of the notes below before installation or use of your new cartridge.

#### Installation of your NH<sub>3</sub> Cartridge

To install the cartridge, follow the instructions below.

*Note: Cartridge Installation or Replacement must never be carried out in a hazardous area.*

- (1) If a cartridge was previously fitted to the Impact into which the NH<sub>3</sub> cartridge is to be installed, remove the Front Cover Grill using the Allen Key provided in the bottom of the Impact. Unscrew the screw in the centre of the cartridge and lift the cartridge from the Impact.
- (2) Place the NH<sub>3</sub> cartridge into the Impact and screw the cartridge fully home using the Allen Key. Guide the cartridge if necessary using your fingers to ensure that it is seated correctly.
- (3) Replace the Pump Seal with the one provided with your cartridge and replace the Front Cover. Refit the Allen Key into the bottom of the Impact.
- (4) Allow 20 minutes for the sensors to stabilise before first use.
- (5) To complete installation of the cartridge, switch the Impact on and accept the New Configuration when prompted to do so.

#### Using your NH<sub>3</sub> Cartridge

Please ensure that the following points are noted when the cartridge is in service.

- (1) The Ammonia channel has an extended warm-up time. Although the other channels of the cartridge will be

reading correctly, the detector should not be used to measure Ammonia until the 'warm up' message has disappeared.

- (2) The operating temperature range of the cartridge defaults to that of the lowest sensor fitted. For NH<sub>3</sub> this is -20°C to +40°C.
- (3) Always use PTFE tubing (maximum length of 500mm) when calibrating the NH<sub>3</sub> channel.
- (4) When performing a Span Calibration on the NH<sub>3</sub> channel it is good practice to flow NH<sub>3</sub> calibration span gas through connected tubing for a minimum of 15 minutes **without the flow adapter fitted to the Impact** before attempting a span calibration. Failure to do so may result in a false calibration of the NH<sub>3</sub> channel.
- (5) The accuracy of the instrument must be functionally checked with known concentration calibration gas before each day's use. If any sensor fails, recalibrate the Impact before using or alternatively replace the cartridge. Please refer to the Impact User Manual on general instructions on how to calibrate.
- (6) Apply calibration span gas at a rate of 300ml/min for a period of 5 minutes before starting the span calibration on the sensor.
- (7) With regard to the actual sensors fitted, please perform span calibrations on the sensors of the Impact cartridge in the following order: Cl<sub>2</sub>, NH<sub>3</sub>, H<sub>2</sub>S, CO, Flammable.
- (8) Purge the system with air for a period of 15 minutes between Cl<sub>2</sub> and NH<sub>3</sub> calibrations to avoid interaction between these two gases.
- (9) The sensors fitted to Impact may give responses to gases other than the target gas. The table below gives typical sensor responses to various gases and should

## 8. ROUTINE SERVICING

be used as a guide only. *Note: Always use the target gas to perform sensor calibrations.*

- (10) Your attention is drawn to the cross-sensitivity of the NH<sub>3</sub> sensor in the presence of H<sub>2</sub>S. This is normal operation and is due to the chemistry of the NH<sub>3</sub> sensor.

<i>Applied Gas</i>	<i>Effect on CO Sensor</i>	<i>Effect on H<sub>2</sub>S Sensor</i>	<i>Effect on CO<sub>2</sub> Sensor</i>	<i>Effect on Cl<sub>2</sub> Sensor</i>	<i>Effect on NH<sub>3</sub> Sensor</i>	<i>Effect on SO<sub>2</sub> Sensor</i>
CO (100ppm)	100ppm	0ppm	0%v/v	0ppm	35ppm	1ppm
H <sub>2</sub> S (40ppm)	0ppm	40ppm	0%v/v	-25ppm <sup>1</sup>	50ppm	1ppm
CO <sub>2</sub> (0.5%v/v)	0ppm	0ppm	0.5%v/v	0ppm	0ppm	TBA
Cl <sub>2</sub> (5ppm)	0ppm	0ppm	0%v/v	5ppm	0ppm	-2ppm <sup>1</sup>
NH <sub>3</sub> (50ppm)	0ppm	0ppm	0%v/v	-2ppm <sup>1</sup>	50ppm	TBA
Hydrogen (1000ppm)	200ppm	0ppm	0%v/v	TBA	35ppm	TBA
SO <sub>2</sub> (10ppm)	0ppm	0ppm	0%v/v	2ppm	0ppm	10ppm

<sup>1</sup> Reading displayed as -0ppm.

---

## 8. ROUTINE SERVICING

---

### Special Notes for SO<sub>2</sub> Cartridges

It is important that you read all of the notes below before installation or use of your new cartridge.

#### Installation of your SO<sub>2</sub> Cartridge

*Note: Cartridge Installation or Replacement must never be carried out in a hazardous area.*

- (1) If a cartridge was previously fitted to the Impact Pro into which the SO<sub>2</sub> cartridge is to be installed, remove the Front Cover Grill using the Allen Key provided in the bottom of the Impact Pro. Unscrew the screw in the centre of the cartridge and lift the cartridge from the Impact Pro.
- (2) Place the SO<sub>2</sub> cartridge into the Impact Pro and screw the cartridge fully home using the Allen Key. Guide the cartridge if necessary using your fingers to ensure that it is seated correctly.
- (3) Replace the Pump Seal with the one provided with your cartridge and replace the Front Cover. Refit the Allen Key into the bottom of the Impact Pro.
- (4) Allow 20 minutes for the sensors to stabilise before first use.
- (5) To complete installation of the cartridge, switch the Impact Pro on and accept the New Configuration when prompted to do so.

#### Using your SO<sub>2</sub> Cartridge

Please ensure that the following points are noted when the cartridge is in service.

- (1) The operating temperature range of the cartridge defaults to that of the lowest sensor fitted.

---

## 8. ROUTINE SERVICING

---

- (2) Always use PTFE tubing (maximum length of 500mm) when calibrating the SO<sub>2</sub> channel.
- (3) When performing a Span Calibration on the SO<sub>2</sub> channel it is good practice to flow SO<sub>2</sub> calibration span gas through connected tubing for a minimum of 15 minutes ***without the flow adapter fitted to the Impact*** before attempting a span calibration. Failure to do so may result in a false calibration of the SO<sub>2</sub> channel.
- (4) The accuracy of the instrument must be functionally checked with known concentration calibration gas before each day's use. If any sensor fails, recalibrate the Impact before using or alternatively replace the cartridge. Please refer to the Impact User Manual on general instructions on how to calibrate.
- (5) Apply calibration span gas at a rate of 300ml/min for a period of 1 minute before starting the span calibration on the sensor.
- (6) With regard to the actual sensors fitted, please perform span calibrations on the sensors of the Impact cartridge in the following order: Cl<sub>2</sub>, NH<sub>3</sub>, H<sub>2</sub>S, SO<sub>2</sub>, CO, Flammable.
- (7) If the cartridge contains either NH<sub>3</sub> or H<sub>2</sub>S sensors purge the system with air for a period of 15 minutes between NH<sub>3</sub> or H<sub>2</sub>S and SO<sub>2</sub> calibrations to avoid interaction between these gases.
- (8) The sensors fitted to Impact may give responses to gases other than the target gas. The table below gives typical sensor responses to various gases and should

## 8. ROUTINE SERVICING

be used as a guide only. *Note: Always use the target gas to perform sensor calibrations.*

Applied Gas	Effect on CO Sensor	Effect on H <sub>2</sub> S Sensor	Effect on CO <sub>2</sub> Sensor	Effect on Cl <sub>2</sub> Sensor	Effect on NH <sub>3</sub> Sensor	Effect on SO <sub>2</sub> Sensor
CO (100ppm)	100ppm	0ppm	0%v/v	0ppm	35ppm	1ppm
H <sub>2</sub> S (40ppm)	0ppm	40ppm	0%v/v	-25ppm <sup>1</sup>	50ppm	1ppm
CO <sub>2</sub> (0.5%v/v)	0ppm	0ppm	0.5%v/v	0ppm	0ppm	TBA
Cl <sub>2</sub> (5ppm)	0ppm	0ppm	0%v/v	5ppm	0ppm	-2ppm <sup>1</sup>
NH <sub>3</sub> (50ppm)	0ppm	0ppm	0%v/v	-2ppm <sup>1</sup>	50ppm	TBA
Hydrogen (1000ppm)	200ppm	0ppm	0%v/v	TBA	35ppm	TBA
SO <sub>2</sub> (10ppm)	0ppm	0ppm	0%v/v	2ppm	0ppm	10ppm

<sup>1</sup> Reading displayed as -0ppm.

### Special Notes for CO<sub>2</sub> Cartridges

It is important that you read all of the notes below before installation or use of your new cartridge.

#### Installation of your CO<sub>2</sub> Cartridge

The cartridge is supplied on a Bias PCB to ensure that the sensor is ready to use when installed.

To install the cartridge, follow the instructions below.

*Note: Cartridge Installation or Replacement must never be carried out in a hazardous area.*

- (1) If a cartridge was previously fitted to the Impact into which the CO<sub>2</sub> cartridge is to be installed, remove the Front Cover Grill using the Allen Key provided in the bottom of the Impact. Unscrew the screw in the centre of the cartridge and lift the cartridge from the Impact.
- (2) Again using the Allen Key provided in the base of the Impact instrument, unscrew the screw in the centre of the new CO<sub>2</sub> cartridge. Do not attempt to remove the screw from the bottom of the Bias PCB. Remove the Bias PCB from the Cartridge.

---

## 8. ROUTINE SERVICING

---

- (3) Place the CO<sub>2</sub> cartridge into the Impact and screw the cartridge fully home using the Allen Key. Guide the cartridge if necessary using your fingers to ensure that it is seated correctly.
- (4) Replace the Pump Seal with the one provided with your cartridge and replace the Front Cover. Refit the Allen Key into the bottom of the Impact.
- (5) To complete installation of the cartridge, switch the Impact on and accept the New Configuration when prompted to do so. *Note: This must be done immediately after installation in order to maintain correct bias on the CO<sub>2</sub> sensor.*
- (6) Allow 20 minutes for the sensors to stabilise before use. Note that the Impact may be in alarm condition during this time.

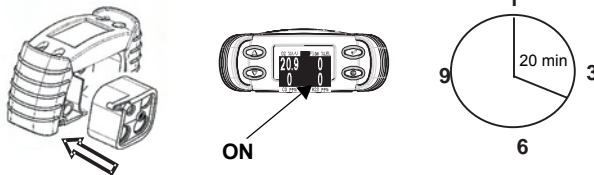

### Using your CO<sub>2</sub> Cartridge

Please ensure that the following points are noted when the cartridge is in service.

- (1) Always keep the instrument batteries charged or keep fresh alkaline cells fitted when the cartridge is installed. Never allow the batteries to become drained.
- (2) The operating temperature range of this cartridge is 0°C to +40°C. Never use or store the cartridge in temperature outside of this range; permanent damage to the sensor may result.

## 8. ROUTINE SERVICING

- (3) The CO<sub>2</sub> sensor is suitable for use in Barometric Pressures of 1013mBar ± 10%. Over this pressure range, the reading is directly proportional to Barometric Pressure.
- (4) Due to the characteristics of the CO<sub>2</sub> Sensor a significant increase of reading can be expected at temperatures below +10°C. To ensure safe operation, always calibrate the instrument in a temperature of greater than +10°C.
- (5) The accuracy of the instrument must be functionally checked with known concentration calibration gas before each day's use. If any sensor fails, recalibrate the Impact before using or replace the cartridge. Please refer to the Impact User Manual on how to calibrate.
- (6) The sensors fitted to Impact may give responses to gases other than the target gas. The table below gives typical sensor responses to various gases and should be used as a guide only. *Note: Always use the target gas to perform sensor calibrations.*

Applied Gas	Effect on CO Sensor	Effect on H <sub>2</sub> S Sensor	Effect on CO <sub>2</sub> Sensor	Effect on Cl <sub>2</sub> Sensor	Effect on NH <sub>3</sub> Sensor	Effect on SO <sub>2</sub> Sensor
CO (100ppm)	100ppm	0ppm	0%v/v	0ppm	35ppm	1ppm
H <sub>2</sub> S (40ppm)	0ppm	40ppm	0%v/v	-25ppm <sup>1</sup>	50ppm	1ppm
CO <sub>2</sub> (0.5%v/v)	0ppm	0ppm	0.5%v/v	0ppm	0ppm	TBA
Cl <sub>2</sub> (5ppm)	0ppm	0ppm	0%v/v	5ppm	0ppm	-2ppm <sup>1</sup>
NH <sub>3</sub> (50ppm)	0ppm	0ppm	0%v/v	-2ppm <sup>1</sup>	50ppm	TBA
Hydrogen (1000ppm)	200ppm	0ppm	0%v/v	TBA	35ppm	TBA
SO <sub>2</sub> (10ppm)	0ppm	0ppm	0%v/v	2ppm	0ppm	10ppm

<sup>1</sup> Reading displayed as -0ppm.

---

## 8. ROUTINE SERVICING

---

### Charging Procedure for Impact Pro fitted with CO<sub>2</sub> Variant Cartridges

If using Rechargeable Ni-MH Battery Packs, charging should always be carried out with the batteries removed from the instrument. This can be achieved by using the Zellweger Analytics Off-Line Charger. Part numbers of the chargers are given in this section.

- (1) Remove the exhausted batteries using the special tool found in the base of the instrument.
- (2) Immediately place the instrument, with the batteries removed, onto the Base Station, which is connected to a Power Supply Unit (PSU). This will ensure that the CO<sub>2</sub> sensor is correctly biased while the Battery Packs are not present. Alternatively, fit fully charged batteries.
- (3) Place the exhausted batteries into the Off-Line Charger, ensuring that they are charged in pairs (one each side of the red 'Charge' LED). The Off-Line Charger can accept two pairs (4 total) of Rechargeable Battery Packs. The red 'Charge' LED will illuminate while the batteries are present.
- (4) After charging is complete (12 hours minimum), remove the Battery Packs from the Off-Line Charger. Remove the instrument from the Base Station and insert the Battery Packs. Tighten the retaining screw using the special tool.
- (5) The instrument is now ready for use.

*Note: The instrument does not have to be switched on during this procedure, however if it is switched on a Warning 105 (see Section 11 Appendix A) will be shown. This should be accepted. In addition Fault 23 may be reported when the instrument is removed from the Base Station. If this occurs, the instrument should be switched off and back on again to reset the instrument.*

---

## 8. ROUTINE SERVICING

---

### Off-Line Charger and Spare Battery Part Numbers

The following are the part numbers for the Off-Line Charger. Each variant is supplied complete with the relevant PSU for the destination country shown.

- Off-Line Charger Kit (Europe) [2302B1415]
- Off-Line Charger Kit (UK) [2302B1414]
- Off-Line Charger Kit (USA) [2302B1416]
- Off-Line Charger Kit (Australia) [2302B1417]
- Pair of Ni-MH Batteries (UK, Europe, Australia) [2302B0842]
- Pair of Ni-MH Batteries (USA) [2302B2015]

### Using Alkaline Dry Cells

If using Alkaline Cells (Duracell MN1500 or Energizer E91) and they require replacing, ensure that the batteries are not left out of the instrument for more than 15 minutes. This is to ensure correct biasing of the CO<sub>2</sub> sensor.

### WARNING

The following points should be noted.

- (1) The Bias PCB supplied with your CO<sub>2</sub> Cartridge contains a non-rechargeable lithium battery. Do not attempt to recharge the battery under any circumstances.
- (2) Do not reuse the Bias PCB.
- (3) Do not destroy the Bias PCB in fire.
- (4) Dispose of the Bias PCB and cartridge packaging in accordance with Local Regulations.

---

## 8. ROUTINE SERVICING

---

### Special Notes for NO<sub>2</sub> Cartridges

It is important that you read all of the notes below before installation or use of your new cartridge.

#### Installation of your NO<sub>2</sub> Cartridge

*Note: Cartridge Installation or Replacement must never be carried out in a hazardous area.*

- (1) If a cartridge was previously fitted to the Impact Pro into which the NO<sub>2</sub> cartridge is to be installed, remove the Front Cover Grill using the Allen Key provided in the bottom of the Impact Pro. Unscrew the screw in the centre of the cartridge and lift the cartridge from the Impact Pro.
- (2) Place the NO<sub>2</sub> cartridge into the Impact Pro and screw the cartridge fully home using the Allen Key. Guide the cartridge if necessary using your fingers to ensure that it is seated correctly.
- (3) Replace the Pump Seal with the one provided with your cartridge and replace the Front Cover. Refit the Allen Key into the bottom of the Impact Pro.
- (4) Allow 20 minutes for the sensors to stabilise before first use.
- (5) To complete installation of the cartridge, switch the Impact Pro on and accept the New Configuration when prompted to do so.

#### Using your NO<sub>2</sub> Cartridge

Please ensure that the following points are noted when the cartridge is in service.

---

## 8. ROUTINE SERVICING

---

- (1) The operating temperature range of the cartridge defaults to that of the lowest sensor fitted. The temperature range of the NO<sub>2</sub> Sensor is -20°C to +50°C.
- (2) Always use PTFE tubing (maximum length of 500mm) when calibrating the NO<sub>2</sub> channel.
- (3) When sampling remotely (i.e. using the internal sample pump or hand aspirator together with tubing) users should be aware of increased sample times. For NO<sub>2</sub> the sample time will increase by approximately 90 seconds for every 10m of tubing used.
- (4) When performing a Span Calibration on the NO<sub>2</sub> channel it is good practice to flow NO<sub>2</sub> calibration span gas through connected tubing for a minimum of 15 minutes ***without the flow adapter fitted to the Impact*** before attempting a span calibration. Failure to do so may result in a false calibration of the NO<sub>2</sub> channel.
- (5) The accuracy of the instrument must be functionally checked with known concentration calibration gas before each day's use. If any sensor fails, recalibrate the Impact before using or alternatively replace the cartridge. Please refer to the Impact User Manual on general instructions on how to calibrate.
- (6) Apply calibration span gas at a rate of 300ml/min for a period of 1 minute before starting the span calibration on the sensor.
- (7) With regard to the actual sensors fitted, please perform span calibrations on the sensors of the Impact cartridge in the following order: Cl<sub>2</sub>, NH<sub>3</sub>, H<sub>2</sub>S, NO<sub>2</sub>, SO<sub>2</sub>, CO, Flammable.
- (8) If the cartridge contains NH<sub>3</sub>, H<sub>2</sub>S or Cl<sub>2</sub> sensors purge the system with air for a period of 15 minutes between NH<sub>3</sub>, H<sub>2</sub>S or Cl<sub>2</sub> and NO<sub>2</sub> calibrations to avoid interaction between these gases.

## 8. ROUTINE SERVICING

- (9) The sensors fitted to Impact may give responses to gases other than the target gas. The table below gives typical sensor responses to various gases and should be used as a guide only. *Note: Always use the target gas to perform sensor calibrations.*

<i>Applied Gas</i>	<i>Effect on CO Sensor</i>	<i>Effect on H<sub>2</sub>S Sensor</i>	<i>Effect on CO<sub>2</sub> Sensor</i>	<i>Effect on Cl<sub>2</sub> Sensor</i>	<i>Effect on NH<sub>3</sub> Sensor</i>	<i>Effect on SO<sub>2</sub> Sensor</i>	<i>Effect on NO<sub>2</sub> Sensor</i>
CO (100ppm)	100ppm	0ppm	0%v/v	0ppm	35ppm	1ppm	0ppm
H <sub>2</sub> S (40ppm)	0ppm	40ppm	0%v/v	-25ppm <sup>1</sup>	50ppm	1ppm	-3.2ppm <sup>1</sup>
CO <sub>2</sub> (0.5%v/v)	0ppm	0ppm	0.5%v/v	0ppm	0ppm	TBA	TBA
Cl <sub>2</sub> (5ppm)	0ppm	0ppm	0%v/v	5ppm	0ppm	-2ppm <sup>1</sup>	5ppm
NH <sub>3</sub> (50ppm)	0ppm	0ppm	0%v/v	-2ppm <sup>1</sup>	50ppm	TBA	TBA
Hydrogen (1000ppm)	200ppm	0ppm	0%v/v	TBA	35ppm	TBA	TBA
SO <sub>2</sub> (10ppm)	0ppm	0ppm	0%v/v	2ppm	0ppm	10ppm	0ppm
NO <sub>2</sub> (10ppm)	0ppm	0ppm	0%v/v	0ppm	-5ppm <sup>1</sup>	-10ppm <sup>1</sup>	10ppm

<sup>1</sup> Reading displayed as -0ppm.

---

## 9. SPARE PARTS

---

The following spare parts are available from Zellweger Analytics authorised Service Centres, in addition to the accessories listed in Section 6. *ACCESSORIES*.

- (1) Dry Cell Battery Holder (2 off) 2302B0770
- (2) NiMH Rechargeable Battery Pack (2 off) 2302B0842
- (3) Front Cover Grille Assembly 2302B1315
- (4) Stainless Steel Filter Kit (10 off) P2302D0823
- (5) Front Cover O-ring Kit (10 off) 2302B1300
- (6) Rear Cover O-ring Kit (10 off) 2302B1301
- (7) Top O-ring Kit (10 off) 2302B1302
- (8) Sounder Rear Membrane Kit (10 off) 2302B1303
- (9) Interface PCB Seal 1 Kit (10 off) 2302B1304
- (10) Interface PCB Seal 2 Kit (10 off) 2302B1305
- (11) Battery O-ring Kit (10 off) 2302B1306
- (12) Pump Seal Kit (10 off) 2302B1307
- (13) Front Cover Membrane Kit (10 off) 2302B1308
- (14) Sounder Front Seal Kit (10 off) 2302B1309
- (15) Pump Blank Kit 2302B1310
- (16) Pump Adaptor Kit P2302B0814
- (17) Pump Upgrade Kit 2302B1091
- (18) In-line Hydrophobic Filter (10 off) 2302B0845
- (19) Cartridges (as per original supply, contact Zellweger Analytics or distributor)
- (20) Replacement Sensors for Serviceable Cartridges (contact Zellweger Analytics or distributor).
- (21) USA Dry Cell Battery Holders (2 off) 2302B2016
- (22) USA Ni-MH Rechargeable Battery Pack (2 off) 2302B2015
- (23) USA Front Cover Grill Assy 2302B2017

*Note: In order to meet Certification Requirements, fit only Zellweger Analytics component approved flammable sensor.*

---

## 10. GLOSSARY

---

BASEEFA	British Approvals Service for Electrical Equipment in Flammable Atmospheres – UK Safety Certification
Catalytic Sensor	For detection of combustible gases. These are made of an electrically heated platinum wire coil, covered first with a ceramic base such as alumina and then with a final outer coating of palladium or rhodium catalyst dispersed in a substrate of thorium.
CE	Indicates compliance to all relevant European directives
Cell	An individual sensor
CENELEC	Comite Europeen de Normalisation Electrotechnique – European Safety Certification
COSHH	Control of Substances Hazardous to Health
CSA	Canadian Standards Association
dBA	Decibels, relative to the A weighting scale (as affected by the human ear).
Electrochemical Sensor	A gas sensitive electrode, formed by a permeable membrane and special electrolyte.
EMC	Electromagnetic compatibility.
ESD	Electrostatic discharge.
Gas Analyser	Normally refers to equipment used to measure extremely small concentrations of gas (low or sub ppm) or one specific gas in the presence of several others.

---

## 10. GLOSSARY

---

**Gas Detector or Monitor** Refers to equipment designed to alert the user to potentially hazardous concentrations of gas in the monitored atmosphere.

**Hard Zero** When a hard zero is performed using either the built-in calibration menu or the PC software then any adjustments will remain in place when the instrument is turned off. Performing a hard zero followed by an Enforcer calibration, instrument menu span or PC calibration will adjust the calibration and change the calibration due date.

**Hazardous Areas** Areas where there is the possibility of the presence of an explosive mixture of flammable gas or vapour and air are known as 'Hazardous' and other areas as 'safe' or 'non-hazardous'. Any electrical equipment used in hazardous areas must be tested and approved to ensure that, in use even under fault conditions, it can not cause an explosion.

In Europe, hazardous areas are defined as follows:

**Zone 0:** An area where an explosive mixture is likely to be present at all times, under normal operating conditions.

**Zone 1:** An area where an explosive mixture is likely to occur in normal operation.

**Zone 2:** An area where an explosive mixture is not likely to occur in normal operation, and if it does it is only for short periods.

---

## 10. GLOSSARY

---

In the US, hazardous areas are classified in 2 divisions:

**Division 1:** Equates to Zone 0 and Zone 1

**Division 2:** Equates to Zone 2

Intrinsically safe	(approval by an appropriate authority to use the instrument in hazardous area).
IP	Ingress Protection – a measure of protection against the ingress of dust and water
IS	Intrinsically Safe (approval by an appropriate authority to use the instrument in hazardous area).
LED	Light emitting diode.
LEL	Lower Explosive Limit – is the lowest concentration of ‘fuel’ in air which will burn and for most flammable gases and vapours it is less than 5% by volume.
LEL%	Percentage of the Lower Explosive Limit (for example, 10% LEL of methane is approx 0.5% by volume).
LTEL	Long Term Exposure Limit. The 8 hour LTEL is the time-weighted average concentration for a normal 8 hour day to which most workers may be repeatedly exposed, day after day, without adverse effect.
Oz	Ounce (weight).
Peak	Maximum, or minimum, measurement since switch on.
Pellistor	Registered trade name for a commercial device – A very small sensing element used in catalytic

---

## 10. GLOSSARY

---

	sensors and sometimes also called a 'bead' or a 'siegestor'.
Poison resistant	Capability of a catalytic sensor to reduce the effect of inhibiting substances or contaminants, such as silicones.
PPB	Parts per billion concentrations in the atmosphere.
PPM	Parts per million concentrations in the atmosphere.
RFI	Radio frequency interference.
Safe Area	Work area in which there is no danger of contamination with explosive gases.
Soft Zero	When a soft zero is performed (i.e. the autozero on startup) any adjustments will only remain in place whilst the instrument remains switched on. Performing a soft zero (autozero) followed by an Enforcer calibration or instrument calibration menu span (i.e. not a menu zero first) will adjust the calibration whilst the instrument remains switched on but will not change the calibration due date.
STEL	Short Term Exposure Limit, usually monitored over 15 minute periods
TWA	Time-Weighted Average
UEL	Upper Exposure Limit
UL	Underwriters Laboratories (USA)
%VOL	Concentration of gas, measured in percentage by volume.
%V/V	Another way of representing %VOL

## 11. APPENDIX A

### 11.1 WARNING CODES

Number	Message	Action or Reason
8	Replace batteries.	Battery unchargeable. Replace the battery pack.
9	Cartridge expired	Fit new cartridge.
10	Cartridge expires in nn days	Fit new cartridge.
11	Calibration due	Calibration is due soon. Recalibrate or fit new cartridge.
14	Battery low	Recharge battery or fit new battery pack.
16	Pump fault	<ul style="list-style-type: none"> <li>• The pump is expected but not fitted.</li> <li>• The pump calibration has failed.</li> </ul>
17	Pump blocked	<ul style="list-style-type: none"> <li>• Check and remove the blockage.</li> <li>• Check for water or dust in the sampling tube.</li> <li>• Once the above has been checked, press the ✓ button to restart the pump.</li> </ul>
19	Passed install by date	Cartridge has exceeded its storage life. Fitting cartridge will reduce lifetime of cartridge and affect warranty.
20	See manual	Cartridge not being activated. Contact Service Centre
24	Please recharge or replace batteries	Insufficient battery voltage to operate the Enforcer. Recharge battery or replace the battery pack.
25	Calibration required.	Recalibrate or fit new cartridge.

## 11. APPENDIX A

Number	Message	Action or Reason
26	See manual	Operating temperature specification exceeded. Operate instrument within its specification.
29	Communications error	Check connections to basestation.
30	Time/date not set	Set clock using PC software
31	Event log nearly full. Clear log to reset.	20% or less remaining. When full the instrument will start overwriting the oldest data. Download the log to retain oldest data.
32	Gas log nearly full. Clear log to reset.	20% or less remaining. When full the instrument will start overwriting the oldest data. Download the log to retain oldest data.
33	Cal log nearly full. Clear log to reset.	20% or less remaining. When full the instrument will start overwriting the oldest data. Download the log to retain oldest data.
36	See manual	Memory error in alternative language. Instrument will revert to English.
50	Switch on/off to reset	<ul style="list-style-type: none"> <li>• An electronics fault has occurred.</li> <li>• One of the sensors has detected a gas that has caused a large negative cross-sensitivity.</li> </ul>
51	Calibration required	Cell is producing an excessive negative reading. Recalibrate.
52	See manual	Sensor overrange. Switch instrument on and off
53	Calibration required	Flammable sensor has been exposed to more than 100ppm H <sub>2</sub> S. Recalibrate.

## 11. APPENDIX A

Number	Message	Action or Reason
54	Low O <sub>2</sub> – flam inaccurate	Insufficient oxygen for the flammable sensor to operate accurately. Recalibrate or fit new cartridge.
56	Switch on/off to reset	<ul style="list-style-type: none"> <li>• Faulty sensor or poor cartridge contact</li> <li>• Remove and refit cartridge</li> <li>• Replace suspect sensor (serviceable cartridge)</li> <li>• Replace cartridge.</li> </ul>
57	Switch on/off to reset	<ul style="list-style-type: none"> <li>• Software Algorithm Error</li> <li>• Switch instrument off and back on to clear the fault.</li> </ul>
58	Switch on/off to reset	<ul style="list-style-type: none"> <li>• Failure of the ADC has been detected</li> <li>• Switch instrument off and back on to clear the fault.</li> <li>• If fault persists, contact supplier.</li> </ul>
104	Switch on/off to reset	Oxygen cell fault. Recalibrate or fit new cartridge.
105	Switch on/off to reset	Flammable cell fault. Possible flammable fuse broken. Recalibrate or fit new cartridge
106	Switch on/off to reset	Toxic 1 cell fault. Recalibrate or fit new cartridge
107	Switch on/off to reset	Toxic 2 cell fault. Recalibrate or fit new cartridge

## 11. APPENDIX A

### 11.2 FAULT CODES

Number	Message	Action or Reason
1	Clear log to reset.	Log memory error. Clear the event log
2	Clear log to reset.	Log memory error. Clear the gas log
3	See manual	Memory fault
4	Insert valid cartridge	Insert a valid cartridge. If one is fitted, remove and refit.
5	Insert valid cartridge	Memory error. Replace cartridge.
6	Insert valid cartridge	An Impact instrument does not support serviceable cartridges.
7	Insert valid cartridge	Sensor mix incorrect. Replace cartridge for the required type. This is only generated if the user declines to accept the cartridge's alarm settings.
12	Check batteries	Mixed battery types, i.e. one dry cell, one rechargeable. Fit two of the same type.
13	Battery empty. Check batteries	Battery too low to operate instrument. Recharge battery or fit new battery pack.
15	Switch on/off to reset	Memory error.
18	See manual	Memory error. Incorrect firmware.
21	Contact service centre	Memory error. An instrument parameter is out of the permitted range.
22	Contact service centre	Memory error. A cartridge parameter is out of the permitted range.

## 11. APPENDIX A

Number	Message	Action or Reason
23	Switch on/off to reset	Caused by an unexpected switch off, e.g. poor or intermittent battery contacts. Switch off instrument and switch on again.
27	See manual	Operating temperature specification exceeded. Operate instrument within its specification.
28	Insert valid cartridge	Cartridge has been removed whilst instrument is still switched on. Switch off and fit cartridge.
34	See manual	Memory error. A sensor parameter is out of the permitted range.
35	Insert valid cartridge	Memory fault. Incorrect format.
200	Switch on/off to reset	<ul style="list-style-type: none"> <li>• A generic software fault has occurred.</li> <li>• Switch instrument off and back on to clear the fault.</li> <li>• If fault persists, contact supplier.</li> </ul>

## 12. APPENDIX B

### 12.1 WARRANTY

Zellweger Analytics operates a standard warranty statement.

### 12.2 CERTIFICATION APPROVALS

Europe	CENELEC (ATEX) BAS 01 ATEX 1216 Ex 112G EEX ia d IIC T4 (-20°C to +55°C)
North America	UL Ex ia Class 1 Div 1 Group ABCD T4 T <sub>amb</sub> (-4°F to +131°F). See Control Drawing for Safelink Connection
Australia	TestSafe AUS Ex 02.3809X Ex ia s ZONE 0 I/IIB T4 (-20°C to +55°C)
DMT Performance	DMT 02 ATEX G 001 PFG Nr. 41300502
Canada	CSA Ex ia Class 1 Div 1 Group ABCD T4 T <sub>amb</sub> (-20°C to +55°C).
Brazil	Inmetro BR-Ex ia d IIC T4 T <sub>amb</sub> (-20°C to +55°C).
MDA (Australia)	AUS MDA GD 5053

## 12. APPENDIX B

### 12.2.1 DMT Test Report

The type tested measuring ranges are given below.

Measured Gas	Range
Oxygen	0.0 to 25.0%v/v
Methane	0 to 100%LEL
Propane	0 to 100%LEL
Carbon Monoxide	3 to 500ppm
Hydrogen Sulfide	0.4 to 50.0ppm
Carbon Dioxide	0.2 to 3.0 %v/v

Zero Variation (CO, H<sub>2</sub>S and CO<sub>2</sub> Channels)

Measured Gas	Zero Variation
Carbon Monoxide	6ppm
Hydrogen Sulfide	2ppm
Carbon Dioxide	0.2 %v/v

Long Term Drift CO, H<sub>2</sub>S and CO<sub>2</sub> (Channels after 3 months)

Measured Gas	Zero Drift	Span Drift
Carbon Monoxide	1ppm	6% (relative)
Hydrogen Sulfide	2ppm	2% (relative)
Carbon Dioxide	0.1 %v/v	20% (relative)

### DMT/EXAM TEST REPORT

**PFG-No. 41300502/20.05.2003-14.11.2003**

#### 5. Special Conditions for Safe Use

- The portable gas detector Impact / Impact Pro by Zellweger Analytics Ltd. is, based on the information and test results contained in the test reports PFG-No. 41300502P and PFG-No. 41300502P NI suitable for the measurement of Carbon Monoxide up to 500 ppm CO, Hydrogen Sulphide

---

## 12. APPENDIX B

---

up to 50 ppm H<sub>2</sub>S, Carbon Dioxide up to 3 % CO<sub>2</sub> and Oxygen up to 25 % (based on the use for monitoring the atmosphere of oxygen deficiency and enrichment), if it's properties and design conform to the documents listed in the test reports PFG-No. 41300502P and PFG-No. 41300502P NI if it is used accordingly and if the following conditions are met:

- The operating (manual) presented and approved by EXAM is to be followed in detail. It is essential that the instructions for correct use are followed.
- Prior to operating the gas detector it has to be checked whether the response times are sufficiently low, so that alarms triggered by the apparatus are generated as fast as possible so that, critical situations can be avoided. If necessary, the alarm levels need to be set well below the safety related limits.
- A calibration for the instrument with a measuring range of 0 - 3 % CO<sub>2</sub> must only be performed at temperatures > 10 °C.
- A permanent displayed value of -0.0 in the measuring range of 0 - 3 % CO<sub>2</sub> requires an immediate calibration of the instrument.
- The first alarm level (A1) in the measuring range of 0 - 3 % CO<sub>2</sub> must not exceed 0.5 % CO<sub>2</sub>.
- For the measuring range 0 - 3 % CO<sub>2</sub> the STEL and LTEL time weighted average values may exceed the true values due to the behaviour of the sensor.
- It should be noted that sampling of oxygen deficient gases using the integrated pump could result in values measured/ displayed being slightly higher than permitted.
- When extracting gases with the integrated pump in combination with additional probes the increased response time of the sensors needs to be taken into consideration.

---

## 12. APPENDIX B

---

- The calibration needs to be checked, especially that of the H2S channel, if the instrument was subjected to excessive mechanical shock (e.g. dropping the instrument from normal operational height).
- The confidence beep must be activated.
- The BG information BGI 518 and BGI 836 (4, 5) need to be read and understood.
- The instruments shall be labelled with a permanent label, including information regarding the manufacturer, type and serial no. and the inscription:

PFG-No. 41300502'

- Additional marking instructions, according to EU Directive 94/9/EG in particular, are unaffected. The manufacturer confirms with this type label that the instrument supplied contains the documented features and technical characteristics as described in this report. Each instrument without such a label does not conform to this report.
- An entire copy of this report and the test reports PFG-No. 41300502 and PFG-No. 41300502P NI will be made available upon the request of the user.

## 12. APPENDIX B

### 12.2.2 Safelink Connection Drawing

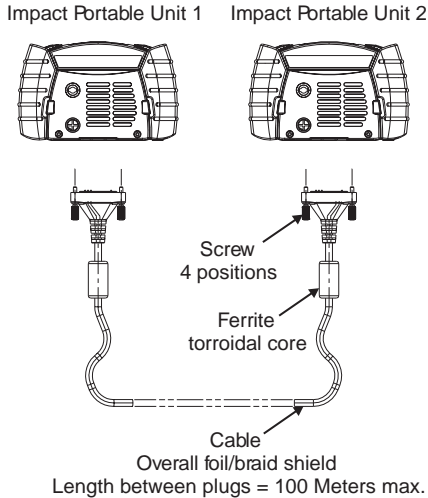

*Notes: 1. Only two units may be permitted to be connected.*

*2. Safelink cable assembly is connected to 'Data Connector' on base of impact portable and retained via 2 position screws into baseplate.*

*3. Cable is 2 connector with overall foil/braid shield.*

Data Connector	Data Connector
PIN 12 (CAN H)	PIN 12 (CAN H)
PIN 13 (CAN L)	PIN 13 (CAN L)
PIN 14 (DGND)	PIN 14 (DGND)

*PIN 14 Connects to braid/screen*

*4. Alternatively, interconnection may be made between impact units located in hazardous and non hazardous areas.*

## 12. APPENDIX B

### 12.3 TECHNICAL SPECIFICATIONS

#### 12.3.1 Instrument Specification

<b>Weight</b>	520g (18oz) including rechargeable battery packs and pump					
<b>Dimensions</b>	49mm x 84mm x 136mm (1.9" x 3.3" x 5.3")					
<b>Sensors</b>	Range	Repeatability	Response Time (T <sub>90</sub> )	Warm-up time (s)	Impact	Impact Pro
Flammable	0 to 100%lel	±3%lel	See 12.3.3	70	✓	✓
Methane	0 to 5%v/v	±0.1%v/v	<10s	70	✓	✓
Oxygen	0 to 25%v/v	±0.3%v/v	See 12.3.3	70	✓	✓
Carbon monoxide	3 to 500ppm	±12.5ppm	See 12.3.3	70	✓	✓
Hydrogen sulfide	0.4 to 50.0ppm	±2.5ppm	See 12.3.3	70	✓	✓
Sulfur dioxide	0 to 20ppm	±1ppm	<60s	70		✓
Chlorine	0 to 10ppm	±0.5ppm	<60s	70		✓
Chlorine dioxide	0 to 5ppm	±0.2ppm	<60s	70		✓
Nitrogen dioxide	0 to 20ppm	±1ppm	<60s	70		✓
Ammonia	0 to 100ppm	±5ppm	<90s	250		✓
Carbon dioxide	0.2 to 3%v/v	±0.2%v/v	See 12.3.3	70		✓
<b>Visual alarm</b>	4 High intensity red LEDs (alarms, fast charge indication) 2 High intensity green LEDs (confidence signal, trickle charge indication)					
<b>Audible alarm</b>	>85dBA at 1m (>90dBA at 1ft)					
<b>Display</b>	Large backlit graphical liquid crystal display					
<b>IP Rating</b>	Instrument IP65 (NEMA 4X), Cartridge IP54 (NEMA 4)					
<b>Operating temperature</b>	-20°C to +55°C (-4°F to +131°F) Carbon Dioxide: 0°C to +40°C (+32°F to +104°F) Ammonia: -20°C to +40°C (-4°F to +104°F)					
<b>Storage Temperature &amp; Time</b>	Instrument, spare parts and accessories: -40°C to +80°C (-40°F to +176°F) Cartridge and replacement sensors: -10°C to +60°C (+14°F to +140°F) 6 months maximum Carbon Dioxide Cartridge and replacement sensors: 0°C to +40°C (+32°F to +104°F) 6 months maximum Ammonia Cartridge and replacement sensors: -10°C to +40°C (+14°F to +104°F) 6 months maximum					
<b>Pressure</b>	800mBar to 1200mBar Carbon Dioxide Cartridge 910mBar to 1110mBar					
<b>Humidity</b>	20 to 90% continuous					
<b>Pump (where fitted)</b>	0.3 litres/minute over 20m (66") Flow fail detection and pump shutdown system under blocked flow Test and Calibration routine of flow fail detection circuit					

## 12. APPENDIX B

<b>EMC Approvals</b>	EN50270
<b>Battery</b>	NiMH rechargeable, operating life (non-pumped) >10 hours, (pumped) >8 hours. Charge time = 7 hours Dry Cell disposable, operating life (non-pumped) >17 hours, (pumped) >15 hours.
<b>Internal Battery (clock and memory)</b>	>5 years operating life.

### 12.3.2 Charger Specifications

2302D0816	230Vac 50Hz Euro plug format, 12Vdc 500mA regulated output
2302D0818	230Vac 50Hz UK plug format, 12Vdc 500mA regulated output
2302D0819	120Vac 60Hz USA plug format, 12Vdc 500mA regulated output
2302D0820	240Vac 50Hz Australian plug format, 12Vdc 500mA regulated output
2302D0815	12V/24VDC vehicle charger lead

Storage Temperature (all versions):            -20°C to +50°C

Operating Temperature (all versions)        0°C to +35°C

For supplying power to more than one Basestation, linked using the Basestation PSU Link Cable, a power supply capable of supplying 12Vdc to 32Vdc, rated at 500mA per Basestation, is required.

## 12. APPENDIX B

### 12.3.3 Specific Speed of Response Data (Rising Gas Levels)

The following values are typical rising speed of response rise times, given in seconds during various gas-sampling modes of the instrument.

Gas	Sampling Mode (see key) - typical T <sub>90</sub> sampling time (seconds)					
	1	2	3	4	5	6
Oxygen	20	20	150	90	40	30
Methane	15	20	140	80	40	30
Propane	25	25	140	90	40	35
CO	25	20	150	80	40	35
H <sub>2</sub> S	25	40	170	120	50	45

Gas	Sampling Mode (see key) - typical T <sub>80</sub> sampling time (seconds)					
	1	2	3	4	5	6
CO <sub>2</sub>	125	45	235	135	140	110

Gas	Sampling Mode (see key) - typical T <sub>100</sub> sampling time (seconds)					
	1	2	3	4	5	6
CO <sub>2</sub>	590	225	545	420	385	345

## 12. APPENDIX B

### 12.3.4 Specific Recovery Time Data (Falling Gas Levels)

The following values are typical recovery times, given in seconds during various gas-sampling modes of the instrument.

Gas	Sampling Mode (see key) - typical T <sub>10</sub> recovery time (seconds)	
	1	2
CO	25	20
H <sub>2</sub> S	35	35

Gas	Sampling Mode (see key) - typical T <sub>20</sub> recovery time (seconds)	
	1	2
CO <sub>2</sub>	190	105

Gas	Sampling Mode (see key) - typical T <sub>0</sub> recovery time (seconds)	
	1	2
CO <sub>2</sub>	1220	490

**Key:**

- (1) Diffusion Mode
- (2) Pumped Mode (no tubing)
- (3) Pumped Mode (10m of tubing + Ball Float)
- (4) Pumped Mode (10m of tubing + Sample Probe)
- (5) Hand Aspirator (10m of tubing + Ball Float)
- (6) Hand Aspirator (10m of tubing + Sample Probe)